



CATÁLOGO 2023



MADERAS CASAS, S.A.

C/MARQUÉS DE LEMA 160
44550 ALCORISA (TERUEL)

MADERAS TERUEL, S.L.

POL. LA PAZ C/ LISBOA 4
44195 TERUEL (TERUEL)

MADERAS CALATAYUD, S.L.

MADERAS RACASO, SL.

POL MALPICAC/F OESTE 15-16
CP50016 ZARAGOZA

2023.4

30.06.2023

www.maderascasasteruel.com



01.	MADERA (Cepillado, Abeto Aserrado, Pino Insignis, Perfil Ventanas)	03-08
02.	MADERA TRATADA (Rollizos, Tratada y Herrajes)	09-11
03.	VIGA LAMINADA Y TARIMA (Viga laminada, Cubiertas, Perfil Laminada, CLT, Tarima, foro de viga)	12-16
04.	FRISOS DE MADERA (Frisonoble, Frisolar)	17-19
05.	SANDWICH (Thermochip)	20
06.	AISLANTES (Lana de Roca, Corcho, Onduline)	21-26
07.	PINTURAS (Tinte, Aceite de Teka, Matarcomas)	27-29
08.	AGLOMERADO	30
09.	AGLOMERADO HIDROFUGO	31
10.	OSB	32
11.	FIBRA DM	33-34
12.	MELAMINAS (Superpan, Gama Duo)	35-42
13.	TIRAS CANTEADAS Y TABLEX	43-44
14.	RECHAPADO Y CONTRACHAPADO (Natural, Antiderrapante, Calabo)	45-49
15.	TABLEROS ALISTONADOS (Lama Entera, Finger)	50-53
16.	MARCOS (Premarcos)	54-56
17.	PUERTAS (Paso, maciza, PVC, Melamina)	57-96
18.	ARMARIOS (Armarios, Perfiles, Cajones)	97-110
19.	TAPETAS Y BATIDEROS	111
20.	VENTANAS	112-117
21.	COCINAS (Puertas, Complementos, Módulos)	118-138
22.	SUELOS LAMINADOS/MACIZO/VINILO	139-179
23.	MOPA Y RODAPIE	180-184
24.	FRISOS SINTETICOS (Frisos y celosías)	185-187
25.	FERRETERIA / PASAMANOS (Tornillos, Herrajes)	188-193
26.	CONSTRUCCION (Tabla Gallega, Encofrar, Aislantes)	194-195
27.	JARDINERÍA (césped)	196



I. MADERA

STOCK

CEPILLADO:



- PINO FLANDES C/C 25*175 mm
- PINO FLANDES V 25*175 mm
- PINO FLANDES V 50*200 mm

ABETO ASERRADO:

- 22*125mm
- 25*150mm
- 28*150mm
- 38*150mm
- 38*180mm
- 38*225mm
- 38*240mm
- 47*150mm
- 47*225mm
- 47*245mm
- 50*150mm
- 50*225mm
- 50*245mm

PINO INSIGNIS:

- 20*180mm
- 20*200mm
- 38*150mm
- 38*225mm
- 38*300mm
- 50*150mm
- 50*300mm
- 50*400mm
- 50*450mm
- 63*300mm
- 75*250mm
- 75*300mm



info@madeter.com
info@racaso.com

maderascasas@maderascasas.com

www.maderascasasteruel.com

PINO:

PINO FLANDES A / B	PINO FLANDES B	PINO FLANDES C/C	PINO FLANDES C/C
- 38*225mm.	- 63*100mm	- 25*100mm.	- 63*100mm.
- 50*150mm.	- 67*90mm	- 25*125mm.	- 63*125mm.
- 50*200mm.	- 75*75mm	- 25*150mm.	- 63*175mm.
- 50*225mm.	- 75*90mm	- 25*175mm.	- 63*200mm.
- 63*100mm.	- 75*125mm	- 25*200mm.	- 75*125mm.
- 63*125mm.	- 75*130mm	- 25*225mm.	- 75*150mm.
- 63*200mm.		- 38*150mm.	- 75*175mm.
- 67*90mm.		- 38*175mm.	- 75*200mm.
- 75*75mm.		- 38*200mm.	- 75*225mm.
- 75*90mm.		- 38*225mm.	
- 75*100mm.		- 50*100mm.	
- 75*125mm.		- 50*125mm.	
- 75*200mm.		- 50*150mm.	
- 75*252mm.		- 50*200mm.	
		- 50*225mm.	
		- 50*250mm.	

PINO FLANDES SF

- 32*100mm
- 38*100mm
- 42*120mm
- 50*250mm
- 100*200mm



PINO:

PINO FLANDES V

- 25*100mm.
- 25*150mm.
- 25*200mm.
- 25*250mm.
- 32*175mm.
- 32*200mm.
- 32*225mm.
- 38*150mm.
- 38*200mm.
- 38*225mm.
- 50*175mm.
- 50*200mm.
- 50*250mm.
- 63*100mm.
- 63*125mm.
- 63*150mm.
- 63*175mm.
- 75*125mm.
- 75*150mm.
- 75*175mm.
- 75*200mm.
- 75*225mm.

PINO FLANDES VI

- 19*100mm.
- 19*125mm.
- 25*100mm.
- 25*150mm.
- 32*150mm.
- 32*200mm.
- 32*225mm.
- 38*200mm.
- 38*225mm.
- 47*125mm.
- 50*175mm.
- 50*200mm.
- 50*225mm.
- 50*250mm.
- 75*100mm.
- 75*150mm.
- 100*200mm.



MADERA:

- VIGA PINO:**
- 150*100*4000.5000.6000
 - 200*100*4000.5000.6000
 - 200*150*6000
 - 200*200*6000
-

VIGA PINO PELADA UNA CARA:

LARGOS

4 metros/ 5 metros/ 6 metros



LISTONES DE MADERA:

Consultar Disponibilidad.



MATERIAL
- 20*13
- 25*25
- 40*20
- 40*40
- 45*10
- 45*15

MATERIAL
- 45*20
- 45*30
- 45.45
- 60.35
- 60.40
- 60.45
- 70*45



info@madeter.com
info@racaso.com

maderascasas@maderascasas.com

OTRAS MADERAS

ROBLE



GRUESO

- 27mm
- 32mm
- 52mm
- 65mm
- 76mm

HAYA VAP.



GRUESO

- 27mm
- 38mm
- 52mm
- 76mm
- 63 mm

PINO MELIS



GRUESO

- 27mm
- 32mm
- 52mm
- 65mm
- 76mm

PINO GALLEGO



GRUESO

- 20mm
- 30mm

FRESNO AMERICANO



GRUESO

- 38mm

HAYA VAP.



GRUESO

- 27mm
- 32mm
- 60mm
- 65mm



PERFIL LAMINADO FINGER

MEDIDAS

- PERFIL 96*75*6000
- PERFIL 96*95*6000
- PERFIL 72*86*6000
- PERFIL 72*75*6000
- PERFIL 72*95*6000

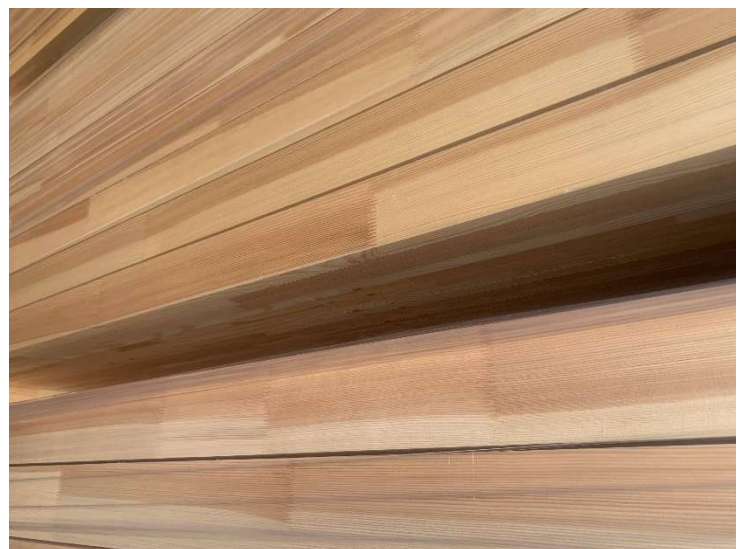
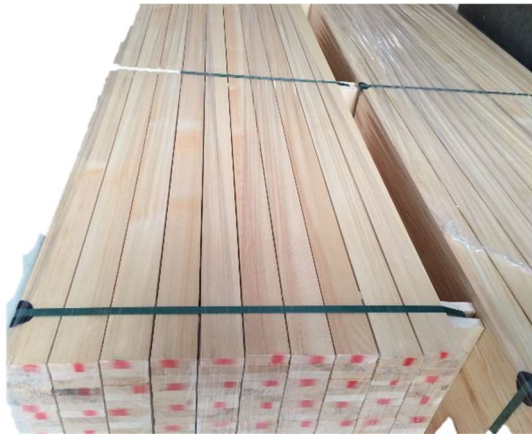

info@madeter.com
info@racaso.com

maderascasas@maderascasas.com

www.maderascasasteruel.com

2. MADERA TRATADA

STOCK

ROLLIZO CILINDRADO RIESGO 4:

Los **rollizos** cilíndricos y calibrados de madera están **tratados** por el proceso de **autoclave** para una **clase de riesgo 4** (madera en contacto directo con el suelo o con agua dulce y expuesta a una humidificación permanente sin mantener contacto con agua salada).



Stock Disponible:

DIÁMETRO	LARGOS
- Diámetro 6 (con punta)	2m
- DIÁMETRO 8	2m / 2.5m / 3m
- DIÁMETRO 8 (con punta)	2m / 2.5m
- DIÁMETRO 10	2.5m / 3m
- DIÁMETRO 12	2m / 3m



info@madeter.com
info@racaso.com

maderascasas@maderascasas.com

www.maderascasasteruel.com

MADERA TRATADA RIESGO 4:

Disponemos stock **madera cepillada de Pino Flandes** con el método autoclave para una **clase de riesgo 4** que significa madera apta para uso exterior o interior expuesta a humidificación permanente incluso protegida para el contacto con tierra o suelo.



Sección

- 100*25
- 100*50
- 100*100
- 150*25
- 150*50
- 150*75
- 150*32
- 200*100



info@madeter.com
info@racaso.com

maderascasas@maderascasas.com

www.maderascasasteruel.com

RASTREL TRATADO RIESGO 4:

Consultar Disponibilidad.



Sección

- 25*70mm
- 27*42mm
- 28*45mm
- 38*45mm
- 45*80mm

MESA PICNIC MADERA TRATADA



PAPELERA MADERA TRATADA



HERRAJES

Unión Tejana: para unión de postes verticales y horizontales en un vallado Tejano o torneado.

Stock Disponible:



MATERIAL

- UNIÓN TEJANA
- TORNILLO
- SOPORTE REDONDO



info@madeter.com
info@racaso.com

maderascasas@maderascasas.com

www.maderascasasteruel.com

3. VIGA LAMINADA Y TARIMA

Consultar Disponibilidad.

Las vigas laminadas son elementos para construcciones en madera que se fabrican a partir de tabloncillos de abeto secados técnicamente, a los que se les recorta los defectos que disminuyen la estabilidad y los defectos ópticos tales como nudos, grandes bolsas de resina. Eliminando los puntos débiles y superponiendo capas se obtiene el producto de alta tecnología.

SECCIONES Alto x Ancho	MEDIDAS CORTE VIGUETAS	SECCIONES Alto x Ancho	MEDIDAS CORTE VIGAS DE CARGA	
100*100	3 - 4 - 6 - 8 - 12	240*200	3.37 - 4 - 6 - 6.75 - 8 9.5 - 12 - 13.5	
120*60		240*240		
140*140		280*200		
120*80		320*200		
160*80	3 - 3.37 - 4 - 4.5 5 - 6 - 6.75 - 7 - 7.5 8 - 8.5 - 9 - 9.5 10 - 12 - 13.5	320*240		
160*100		360*200		
160*120		360*240		
160*140		400*200		
200*80		3.37 - 4 - 6 - 6.75 - 8 9.5 - 12 - 13.5		440*240
200*100				
200*120				
200*140				
200*160				
200*200				
240*100				
240*120				
240*140				
240*160				
280*120				
280*140				
320*120				
320*160				

SECCIÓN DE VIGAS EN ANCHO DE 20mm

SECCIÓN DE VIGAS EN ALTO DE 40mm

*SECCIÓN Y LARGO A MEDIDA, BAJO PEDIDO. CONSULTAR PRECIO Y PLAZO DE ENTREGA

*POSIBILIDAD DE SERVIR CUBIERTAS MECANIZADAS, BARNIZADAS, ETC.

*POR EL VOLUMEN QUE CONLLEVA DISPONER DE TODAS LAS SECCIONES, CONSULTEN ANTES NUESTRO STOCK.



info@madeter.com
info@racaso.com

maderascasas@maderascasas.com

www.maderascasasteruel.com

CUBIERTAS DE MADERA



TIJERA ESPAÑOLA:

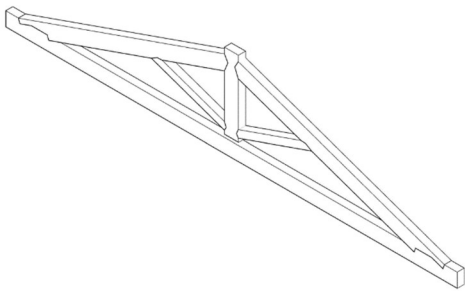

COLAS DE MILANO EN LIMATESA

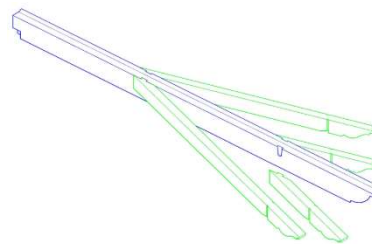

MECANIZADO DE VIGAS

CANETES:

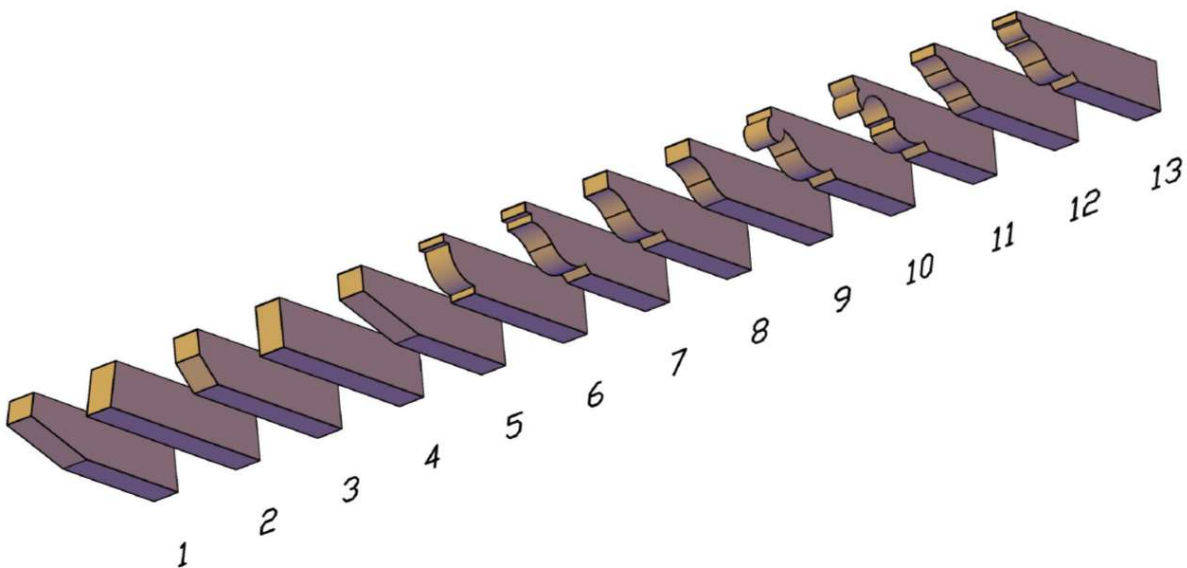

info@madeter.com
info@racaso

maderascasas@maderascasas.com

ascasasteruel.com

FORRO DE VIGAS

- TRADICIONAL 4200*143*45 mm.ml
- CANTO RECTO 4800*143*45 mm.ml



info@madeter.com
info@racaso.com

maderascasas@maderascasas.com

www.maderascasasteruel.com

MADERA CONTRALAMINADA CLT

[Consultar Disponibilidad.](#)

Madera laminada Cruzada. Así podemos decir que el CLT es un laminado de tablas de madera que se cruzan usando como referencia las vetas naturales.

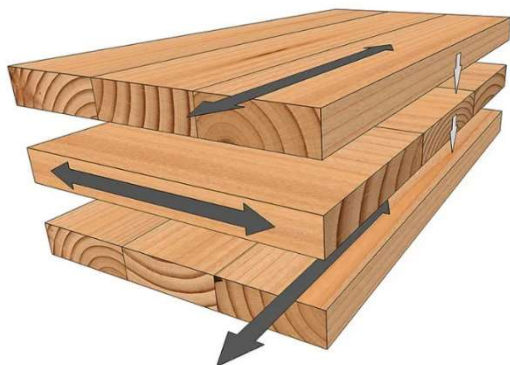

PERFIL LAMINADO:

Perfiles de elementos H B E según DIN 1052

Se usan como elementos para techos, cubiertas o cerramientos:

- *en construcciones de madera maciza
- *construcciones de bastidores de madera
- *en la construcción de estructuras
- *en construcciones de piedra maciza



Material
Perfil Machihembrado 360*100*13500

ESTAQUILLAS DE MADERA:



Material
ESTAQUILLA 400*30*30mm.25ud paquete
ESTAQUILLA 500*32*32mm.25ud paquete

CUÑAS DE MADERA:



Material
CUÑAS 56*50*0.5mm.250ud paquete



info@madeter.com
info@racaso.com

maderascasas@maderascasas.com

TARIMA

STOCK

TARIMA ABETO

MATERIAL

- ABETO BISEL 171*27 mm
- ABETO B 175*31 mm
- ABETO SF 145*27 mm
- ABETO SF 142*32 mm
- ABETO SF 145*22 mm
- ABETO V 146*19 mm

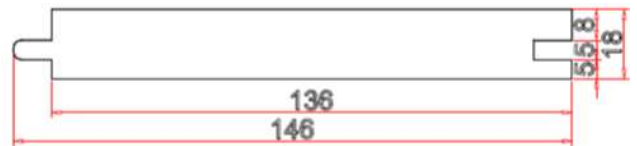
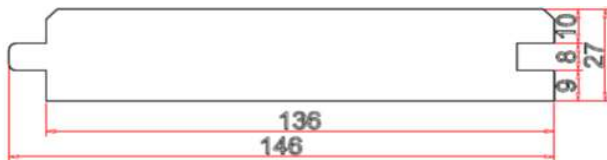

TARIMA PINO

MATERIAL

- PINO FLANDES C/C 145*22mm
- PINO FLANDES V 145*32mm
- PINO FLANDES V 190*22mm
- PINO FLANDES V 195*29mm
- PINO FLANDES V 210*21mm
- PINO GALLEGO 175*23mm
- PINO ROJO SF 145*27mm

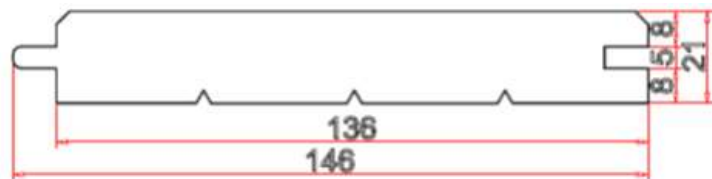
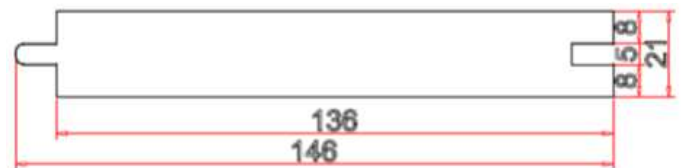

info@madeter.com
info@racaso.com

maderascasas@maderascasas.com

www.maderascasasteruel.com

4. FRISOS DE MADERA

FRISONOBLE (95*10)



FRISOLAR:

Frisolar a diferencia del frisonoble, puede admitir algunos defectos naturales

de la madera en las piezas: 2 bolsas de resina fluida, bolsas de resina seca, entrecasco, 1 nudo saltado o 1 pequeña grieta.



FRISOLAR

- FRISO ABETO NATURAL 95*10mm m2
- FRISO ABETO BARNIZADO 95*10mm m2
- FRISO ABETO TEÑIDO MIEL 95*10mm m2



FRISO DE MADERA MATES

FRISONOBLE ALISTONADO MATE (96*13)



FRISONOBLE MATE (96*13)



info@madeter.com
info@racaso.com

maderascasas@maderascasas.com

www.maderascasasteruel.com

COMPLEMENTOS FRISOS

COMPLEMENTOS FRISONBLE Y FRISOLAR

- RODAPIÉ 70*10 S/B
- RODAPIÉ 70*10 BARNIZ
- RODAPIÉ 70*10 TEÑIDOS
- RINCONERA S/B
- RINCONERA BARNIZ
- RINCONERA TEÑIDOS
- CANTONERA S/B
- CANTONERA BARNIZ
- CANTONERA TEÑIDOS

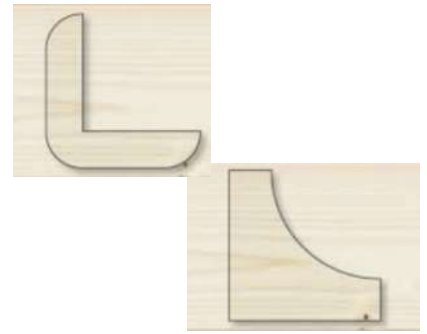

COMPLEMENTOS FRISONBLE MATES

- RODAPIÉ 70*10 S/B
- RODAPIÉ 70*10 BARNIZ
- RODAPIÉ 70*10 TEÑIDOS
- RINCONERA S/B
- RINCONERA BARNIZ
- RINCONERA TEÑIDOS
- CANTONERA S/B
- CANTONERA BARNIZ
- CANTONERA TEÑIDOS



COMPLEMENTOS FRISONBLE MATES ALISTONADO

- RODAPIÉ 70*10 S/B
- RODAPIÉ 70*10 BARNIZ
- RODAPIÉ 70*10 TEÑIDOS
- RINCONERA S/B
- RINCONERA BARNIZ
- RINCONERA TEÑIDOS
- CANTONERA S/B
- CANTONERA BARNIZ
- CANTONERA TEÑIDOS

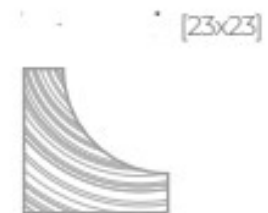

5. PANEL SANDWICH



Thermochip Basic:

STOCK



Material en Stock:

- **THERMOCHIP BASIC AAH/Friso Abeto Barniz** 10mm- Poliestireno 80 mm- Aglom. hidróf. 16mm/ 2400*55*96 mm
- **THERMOCHIP BASIC AAH/Friso Abeto Sin Barniz** 10mm- Poliestireno 80 mm- Aglom. hidróf. 16mm/ 2400*55*96 mm

**SE PUEDE SUMINISTRAR CUALQUIER GAMA, SIEMPRE BAJO PEDIDO A FÁBRICA.



info@madeter.com
info@racaso.com

maderascasas@maderascasas.com

www.maderascasasteruel.com

6. AISLANTES TERMICOS

- LANA DE ROCA:

Consultar Disponibilidad.

ALPHAROCK - E- 225

Panel semi-rígido de lana de roca no revestido.

- APLICACIONES

Aislamiento térmico y acústico de cerramientos verticales, cerramientos horizontales sobre falso techo, en cubiertas inclinadas por el interior, fachadas ventiladas y bajo forjados en contacto por el exterior o espacios no habitables.

MATERIAL DENSIDAD NOMINAL 70KG/M3

- 1350*600*40mm
- 1350*600*60mm



info@madeter.com
info@racaso.com

maderascasas@maderascasas.com

www.maderascasasteruel.com

MONOROCK 365

Panel rígido de lana de roca volcánica no revestido de alta densidad.

- **APLICACIÓN**

Aislamiento térmico y acústico en cubiertas ligeras metálicas de medio-bajo.

- **VENTAJAS:**

La solución estándar para cubiertas de mantenimiento medio-bajo.



MATERIAL DENSIDAD NOMINAL 145KG/M3

- 1200*1000*40mm
- 1200*1000*60mm
- 1200*1000*80mm

ROCKCALM - E- 211

Panel rígido de lana de roca no revestido.

- **APLICACIÓN**

Aislamiento térmico y acústico de cerramientos verticales, cerramientos horizontales sobre falso y bajo forjados en contacto con el exterior o espacios no habitables y en cubiertas inclinadas por el interior.

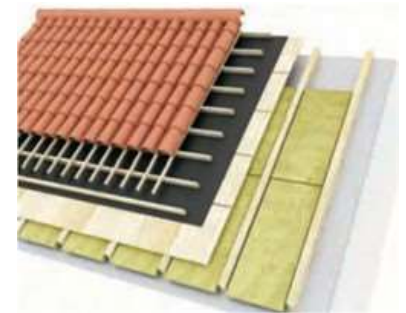

Consulte disponibilidad:

MATERIAL DENSIDAD NOMINAL 40KG/M3

- 1350*600*40mm

CORCHO AGLOCORK:

Solución de alto rendimiento en el aislamiento térmico, acústico y antivibratorio, especialmente indicado para las aplicaciones en paredes exteriores, interiores y dobles; losas, cubiertas planas e inclinadas y suelos radiantes.



GRANULADO CORCHO	Unidad	Valor
Densidad	kg/m3	60-70
Dimension	mm	0-3/3-5/3-10/3-15

Características esenciales	Rendimiento	Resultado
Reacción al fuego	Reacción al fuego	Euroclase E
Resistencia termica	Conductividad termica	0,040 W/m.K
Aislamiento acustico	Aislamiento al ruido aereo	Rw (C;Ctr) = 51 (-2;-6) dB

MATERIAL DISPONIBLE

- **TÉRMICO**
1000*500*60mm
- **SUELOS**
1000*500*40mm



info@madeter.com
info@racaso.com

maderascasas@maderascasas.com

IMPERMEABILIZACIÓN DE TEJADOS:

Onduline®
BAJO TEJA 

LA SOLUCIÓN DEFINITIVA CONTRA GOTERAS Y HUMEDADES

Las placas asfálticas impermeables Onduline Bajo Teja DRS forman una **solución definitiva contra las goteras** dotando al tejado de una protección muy resistente y duradera que protege a la vivienda por muchos años aunque se muevan o desplacen las tejas.



UNA SOLUCIÓN LIGERA, ESTANCA Y VENTILADA, IDEAL PARA LA REPARACIÓN DE TEJADOS

La ligereza de las placas asfálticas impermeables Onduline Bajo Teja DRS facilita y agiliza el proceso de instalación, haciendo más cómodo el trabajo con ellas. Esto hace que sea una solución ideal para la **reparación de tejados**, ya que no sobrecarga la estructura.

Además, su formato ondulado aporta la **ventilación** de tejado para evitar condensaciones por humedades y problemas derivados, por lo que aumenta la durabilidad del resto de componentes, como el aislamiento del tejado, en buenas condiciones.

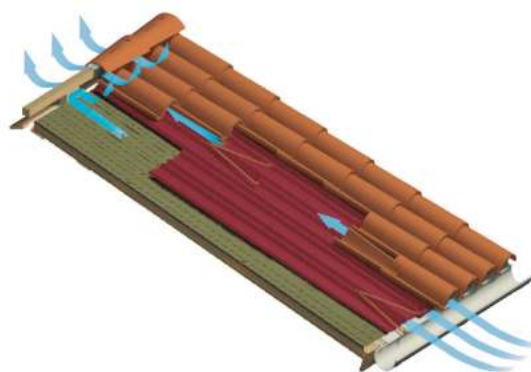

- SISTEMAS DE CUBIERTA Y Onduline® FACHADA:

ONDUVILLA®



ONDUVILLA es la teja asfáltica de Onduline para la impermeabilización y el acabado estético de cubiertas inclinadas.

Se presenta en pequeñas dimensiones 106x40 cm, siendo por ello ideal para el bricolaje y la impermeabilización "casera" de todo tipo de anexos de madera como casetas, porches, pérgolas, cenadores, etc...

ONDUVILLA® está constituido por una mezcla de fibras naturales y resinas termoestables saturadas en asfalto a alta temperatura. Su color obedece a un exclusivo sistema de coloreado a tres tonos que le confiere un atractivo acabado estético, imitando el efecto de solape de las tejas tradicionales y una larga durabilidad de color a la intemperie.

Con la instalación de ONDUVILLA® se dota a la cubierta de un aspecto agradable y una total impermeabilización, con la ventaja añadida de ser muy ligero (4Kg/m²), por lo que se evita sobrecargar estructuras y se facilita su manipulación y colocación.



Impermeable



Ventilación
Cubierta



Ligereza



Fácil
Instalación



Baja
Pendiente



Resistente
a impactos



Estética



info@madeter.com
info@racaso.com

maderascasas@maderascasas.com

www.maderascasasteruel.com

- AISLANTES

► GAMA BARDOLINE

BARDOLINE es la teja asfáltica que garantiza un **tejado completamente protegido** frente a goteras, humedades y condiciones climatológicas extremas, con 10 años de garantía de impermeabilización Onduline. La teja canadiense se puede instalar en tejados de cualquier forma cuya pendiente sea mayor de 20%.

La teja BARDOLINE está disponible en **formato rectangular y ovalado** y en **4 colores** diferentes: rojo, verde, marrón y negro. Las diferentes posibilidades de formato y color permiten que se adapte perfectamente a las necesidades estéticas de cada proyecto.

CARACTERÍSTICAS

Impermeabilización total de cubierta

Acabado estético

Alta resistencia frente a lluvia, viento y heladas

Ideal para trabajos de bricolaje

Instalación más ligera y fácil que la teja

Aplicación en cualquier cubierta inclinada (<20%)
Durabilidad con 10 años de garantía

ACABADO ESTÉTICO DE TEJADOS INCLINADOS



- AISLANTE UNIBULLE:



ECO

- Aislante universal forjados, buhardillas, paredes, bajo parquet y rotura de puente térmico.
- Resistencia térmica con 2 cámaras de aire en pared: $R=1.45 \text{ m}^2.K/W$.

APLICACIONES



MATERIAL DISPONIBLE

- ROLLOS DE 60m2



- POLIESTIRENO EXTRUIDO:

El poliestireno extruido **XPS CW** es el panel de gran formato para el aislamiento de muros en cámara de aire. Presenta una superficie lisa y un acabado machiembrado para facilitar su colocación en vertical.



MATERIAL

- 2600*600*40mm
- 2600*600*60mm
- 2600*600*80mm
- 2600*600*100mm

XPS CW

Aislamiento para muros en cámara de aire



info@madeter.com
info@racaso.com

maderascasas@maderascasas.com

7. PINTURA



STOCK

Variedad en pinturas al agua.



CONSULTAR NUESTRA AMPLIA GAMA DE COLORES.

<http://www.quimicasiris.com/>



info@madeter.com
info@racaso.com

maderascasas@maderascasas.com

www.maderascasasteruel.com

PINTURA Y TRATAMIENTOS:



IRURENA GROUP

PROTECTOR DECORATIVO:

- Acabado coloreado que realza la veta de la madera embelleciéndola y protegiéndola contra la acción nociva del sol, la lluvia y el viento. Cumple la Norma EN927 de “Durabilidad en condiciones de intemperie”.
- Excelente adherencia a todo tipo de maderas (incluidas las de origen tropical y las coníferas).
- Fácil mantenimiento. Basta con lijar suavemente y aplicar una nueva mano del protector decorativo.
- Se recomienda el PROTECTOR DECORATIVO para uso en ambientes de interior.
- Convenientemente aplicado aporta 8 años de protección (máxima durabilidad observada).

MATERIAL	L
- IRUXIL W PROTECTOR BLANCO	0.75
- IRUXIL W PROTECTOR BLANCO	4
- IRUXIL W PROTECTOR NOGAL	0.75
- IRUXIL W PROTECTOR NOGAL	4
- IRUXIL W PROTECTOR ROBLE	0.75
- IRUXIL W PROTECTOR ROBLE	4
- IRUXIL W PROTECTOR TEKA	0.75
- IRUXIL W PROTECTOR TEKA	4
- IRUXIL W PROTECTOR CASTAÑO 440	0.75
- IRUXIL W PROTECTOR INCOLORO	0.75
- IRUXIL W PROTECTOR INCOLORO	4



BARNIZ INTERIORES, ACABADO INCOLORO SATINADO:

MATERIAL	Litros
- IRURENA BARNIZ INTERIORES	0.75
- IRURENA BARNIZ INTERIORES	4



PROTECTOR DECORATIVO, TARIMA EXTERIOR:

MATERIAL	L
- IRURENA PROTECTOR TARIMA EXTERIOR	0.75
- IRURENA PROTECTOR TARIMA EXTERIOR	4



ACEITE DE TEKA:

MATERIAL	Litros
- IRURENA ACEITE DE TEKA	1
- IRURENA PROTECTOR TARIMA EXTERIOR	4



MATA-CARCOMAS:

MATERIAL	Litro
- IRURENA MATA-CARCOMAS	1. litro
	4. litro



RENOVADOR:

MATERIAL	Litros
- IRURENA RENOVADOR	- 0.75



8. TABLERO AGLOMERADO:

TABLERO AGLOMERADO:

STOCK



- *Superficie lisa y homogénea.
- *Admite cualquier tipo de recubrimiento decorativo.
- *Óptimo comportamiento en transformación posterior.
- *Clasificación P2: aplicaciones de interior en ambiente seco.

Stock Disponible:

- *Consultar dimensiones de tableros:

MEDIDAS

- 2440*1220*10 mm
- 2440*1220*19 mm
- 2440*1220*30 mm
- 2440*1220*16 mm
- 2440*1220*25 mm
- 2440*2100*19 mm
- 2850*2100*10 mm
- 2850*2100*16 mm
- 2850*2100*19 mm
- 3660*1830*10 mm
- 3660*2100*10 mm

Tablero de partículas de madera aglomerado, superficie lisa y compacta de fibra de madera. El Superpan posibilita un corte perfecto, antiastillas.



info@madeter.com
info@racaso.com

maderascasas@maderascasas.com

www.maderascasasteruel.com

9. AGLOMERADO HIDROFUGO

Consultar Disponibilidad.

TABLERO AGLOMERADO HIDRÓFUGO:

El aglomerado hidrófugo es un tablero de partículas de madera aglomerado para uso en ambiente húmedo.

*Mayor resistencia al deterioro por efecto de la humedad en exposiciones discontinuas.

* Superficie lisa y homogénea.

*Admite cualquier tipo de recubrimiento decorativo.

*Alta resistencia mecánica.

*Clasificación P3: aplicaciones de interior en ambiente húmedo.

Específico para usos no estructurales en ambiente húmedo.



MATERIAL

- 2440*1220*16 mm
- 2400*1220*19 mm

TABLERO AGLOMERADO HIDRÓFUGO MACHIHEMRADO:

MATERIAL

- 2040*910*19 mm



MELAMINA MACHIHEMRADO:

Superpan Tech4 P4/ Superpan H Tech P5

Clasificado como tablero estructural, clase técnica P4. Tablero estructural para ambiente seco.

Tablero con una cara Lisa de color blanco y otra cara Gris Antideslizante.

Material recomendado para altillos, entre otras funciones.



TABLERO SUPERPANTECH P4 Antideslizante Machiemb.4C GRIS 2400*900*30 mm.m2

TABLERO SUPERPAN H TECH P5 SA TG4 2040*800*16 mm.m2



info@madeter.com
info@racaso.com

maderascasas@maderascasas.com

www.maderascasasteruel.com

10. TABLERO OSB 3:

STOCK

Stock Disponible:

-
- TABLERO 2500*1250*9mm
 - TABLERO 2500*1250*12mm
 - TABLERO 2500*1250*15mm
 - TABLERO 2500*1250*18mm
 - TABLERO 2500*1250*22mm
 - MACHIEMBRADO 4 CANTOS 2500*625*22mm
 - MACHIEMBRADO 4 CANTOS 2500*625*15mm
 - MACHIEMBRADO 4 CANTOS 2500*625*18mm
-



- Gran resistencia a la ruptura y torsión.
- Ausencia de nudos, lo que facilita el mecanizado y los cortes.
- Reciclaje muy sencillo.
- No suele ser atacado por insectos.



info@madeter.com
info@racaso.com

maderascasas@maderascasas.com

www.maderascasasteruel.com

II. FIBRA DM

STOCK

- Superficie homogénea y lisa
- No tiene veta, nudos o anillos como la madera.
- Se comercializa en una muy amplia variedad de formatos, tamaños y espesores.
- Resistencia a la flexión.
- Resistencia a la tracción.
- Trabajabilidad. Excelente comportamiento. Se puede fresar, mecanizar y curvar (dentro de parámetros lógicos).



- | | | |
|------------------|------------------|------------------|
| - 2250*1220*09mm | - 2440*1220*05mm | - 2750*1220*09mm |
| - 2250*1220*10mm | - 2440*1220*09mm | - 2750*1220*12mm |
| - 2250*1220*12mm | - 2440*1220*16mm | - 2750*1220*16mm |
| - 2250*1220*14mm | - 2440*1220*17mm | - 2750*1220*19mm |
| - 2250*1220*15mm | - 2440*1220*19mm | - 2750*1220*22mm |
| - 2250*1220*19mm | - 2440*1220*22mm | - 2850*2100*10mm |
| - 2250*1220*22mm | - 2440*1220*28mm | - 2850*2100*16mm |
| - 2250*1220*28mm | - 2440*2100*07 | - 2850*2100*19mm |
| | - 2440*2100*16 | - 2850*2100*25mm |
| | - 2440*2100*19 | - 2850*2100*30mm |
| | | - 3050*1220*12mm |
| | | - 3050*1220*15mm |
| | | - 3050*1220*19mm |
| | | - 3050*1220*28mm |
| | | - 3660*2070*19mm |
| | | - 3660*2100*10mm |



info@madeter.com
info@racaso.com

maderascasas@maderascasas.com

www.maderascasasteruel.com

TABLERO FIBRA DM HIDRÓFUGO:

DM Hidrófugo. Se modifica la composición del tablero con el fin de mejorar su comportamiento frente a la humedad. A las resinas que se utilizan en este caso como aglutinantes se le añaden aditivos hidrofugantes que frenan y desaceleran en cierta medida el avance y los efectos de la humedad.



MATERIAL	
- 2250*1220*9mm	- 2750*1220*9mm
- 2250*1220*12mm	- 2750*1220*19mm
- 2250*1220*15mm	- 2750*1220*22mm
- 2250*1220*19mm	- 3050*1220*12mm

TABLERO FIBRA DM RANURADO:

Tablero de fibras de madera con ranuras longitudinales decorativas.

MATERIAL
- 2440*1220*9mm Horizontal
- 2440*1220*9mm Vertical



TABLERO FIBRA DM FINLIGHT:

- Ligereza. Disminución considerable del peso de piezas de grandes dimensiones y voluminosas.
- Resistencia y estabilidad.
- Fácil manejo, Finlight admite procesos estándar de manipulación, corte y canteado.



MATERIAL
- 2440*2050*35mm



12. MELAMINA **FINSA superPan**[®]

soluciones en madera

patente n° 99866972.4

Tablero compuesto por caras externas de fibra de madera e interior de partículas de madera, recubierto con papel decorativo impregnado con resinas melamínicas.

Gracias a su superficie lisa y compacta de fibra de madera, el Superpan posibilita un corte perfecto, reduciendo notablemente la eventual probabilidad de esportillado.

El Superpan Decor posibilita una mayor vida útil de las herramientas de trabajo.

STOCK



020 **BLANCO MEDIO**

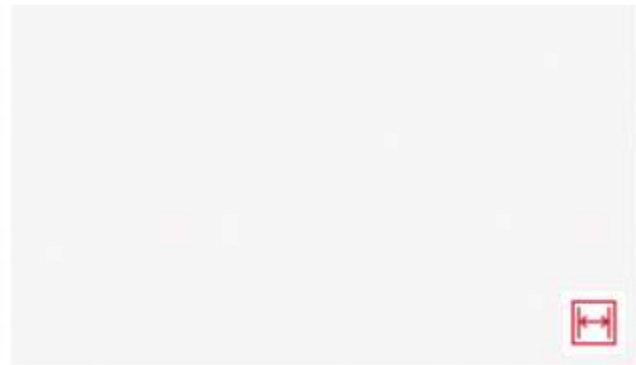

LBE **BLANCO EXTRA LBE**



192 **GRIS AZULADO**

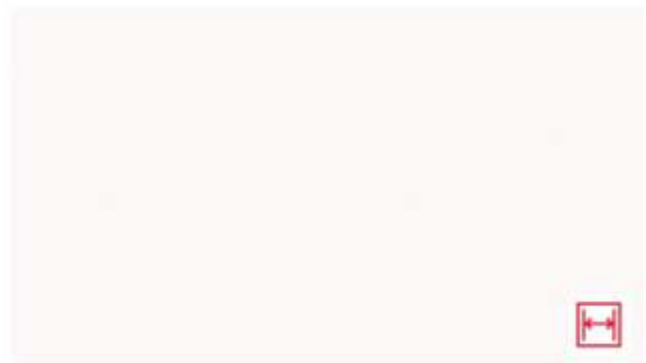

78E **WHITE SR209**



70F **TESSUTO**



890 **ALUMINIO**



info@madeter.com
info@racaso.com

maderascasas@maderascasas.com



73Y **SELENE GRIS**



71A **GRIS GU**



910 **ROBLE NATURAL**



604 **ROBLE ENTABLILLADO**



399 **CEREZO LUNA**



375 **HAYA DAIMIEL**



209 **MAPLE COLONIA**



12G **LINO CANCÚN**



info@madeter.com
info@racaso.com

maderascasas@maderascasas.com



52A WENGE L-01



4AE ROBLE ETERNITY



03C NOGAL CANALETTO



37E RICHMOND PLUM



5AE NOGAL SLOW



274B ROBLE ROMANCE



452B ROBLE COOPER



476B SAONA COGNAC



info@madeter.com
info@racaso.com

maderascasas@maderascasas.com



94Y **IRON OAK**



97V **ROBLE COLORADO**



80Y **ROBLE HÉRCULES**



ROBLE OSTIPPO



455B **NOGAL BOHEME**



251B **LE CER**



008 **ROBLE BELLO**



info@madeter.com
info@racaso.com

maderascasas@maderascasas.com

www.maderascasasteruel.com



464B ARUBA NATURAL



461B ARUBA TOSTADO



264B NAVIA NATURAL



265B NAVIA BROWN



449B OLMO GRACE



475B SAONA TRIGO



info@madeter.com
info@racaso.com

maderascasas@maderascasas.com

www.maderascasasteruel.com

BLANCO MEDIO	- 2440*1220*10/16/19/30mm - 2850*2100*10/16/19/30mm	R. COLORADO	- 2850*2100*10/19/30mm
BLANCO LBE	- 2440*1220*10/16/19/30mm - 2850*2100*10/16/19/30mm	R. ETERNITY	- 2850*2100*10/19/30mm
BLANCO SR209	- 2600*2100*10/16/19mm	R. BELLO	- 2850*2100*10/19/30mm
GRIS AZULADO	- 2440*1220*16mm	R. ROMANCE	- 2850*2100*10/19/30mm
GRIS GU	- 2440*2100*30mm	NOGAL SLOW	- 2850*2100*10/19/30mm
ALUMINIO 890	- 2440*1220*10/16/19mm	IRON OAK	- 2850*2100*10/19/30mm
LINO CANCUN	- 2850*2100*10/16/30mm - 2600*2100*19mm	R. OSTIPPO	- 2850*2100*10/19/30mm
TESSUTO TEXTIL	- 2850*2100*10/16/19mm	LE CER	- 2850*2100*10/19/30mm
SELENE GRIS	- 2850*2100*10/19mm - 2600*2100*16/30mm	OLMO GRCE	- 2850*2100*10/19/30mm
MAPLE BLANCO	- 2440*1220*16/19mm	R. COOPER	- 2850*2100*10/19/30mm
HAYA DAIMIEL	- 2440*1220*10/16/19mm - 2600*2100*10/19mm - 2850*2100*16/30mm	N.RICHMOND PLUM	- 2850*2100*10/19/30mm
CEREZO LUNA	- 2440*1220*10/16/19mm	NOGAL BOHEME	- 2850*2100*10/19/30mm
NOGAL CANALETO	- 2440*1220*10/16mm - 2850*2100*16/19mm	NAVIA BROWN	- 2850*2100*10/19/30mm
WENGUE	- 2440*1220*16mm	NAVIA NATURAL	- 2850*2100*10/19/30mm
		SAONA TRIGO	- 2850*2100*10/19/30mm
R. NATURAL	- 2440*1220*10/16/19mm	SAONA GOGNAC	- 2850*2100*10/19/30mm
R. HERCULES	- 2850*2100*10/19mm - 2600*2100*16mm	ARUBA TOSTADO	- 2850*2100*10/19/30mm
R. ENTABLILLADO	- 2440*1220*10/16/19mm - 2850*2100*10/16mm - 2600*2100*19mm	ARUBA NATURAL	- 2850*2100*10/19/30mm



MELAMINA

STOCK



HYBRYD SAND



HYBRYD GREY

HYBRYD SAND	2850*2100*10mm
	2850*2100*19mm
	2850*2100*30mm

HYBRYD GREY	2850*2100*10mm
	2850*2100*19mm
	2850*2100*30mm



info@madeter.com
info@racaso.com

maderascasas@maderascasas.com

www.maderascasasteruel.com

Consultar Disponibilidad.

La Gama Duo de Finsa se caracteriza por ser la más flexible e innovadora de su sector aportando soluciones a todo tipo de aplicaciones de mobiliario y creación de espacios en más de 80 países.

La colección se renueva este año con 23 nuevos diseños:

Diseños en melamina Gama DUO > Fantasías

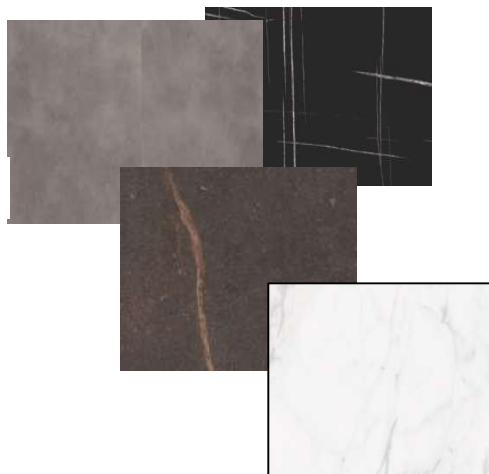

Diseños en melamina Gama DUO > Maderas



Diseños en melamina Gama DUO > Uicolores

Siempre que se pidan tableros sueltos llevará un incremento de 70€ por grosor, es decir, si tenemos un pedido con 2 tableros en 10mm + 3 tableros en 19mm, incrementaríamos a cada grosor 70€ + 70€ + el precio de los tableros.

Para ver los diseños de la Gama Duo, consulta nuestros muestrarios o visita nuestra web

Dimensiones	Grosos mm
2850*2100	8
	10
	16
	18
	19
	22
	25
	30
	40



13. TIRAS CANTEADAS

Tablero compuesto por caras externas recubierto con papel decorativo impregnado con resinas melamínicas a ambos lados.

Soporte interno de fibra de madera e interior de partículas de madera (Superpan).

Tablero canteado a ambos lados con PVC del mismo color, un lateral PVC 1.2mm y el otro lateral PVC 0.4mm



STOCK

TIRA CANTEADA 2440*580*16mm
BLANCO SOFT
HAYA DAIMIEL
MAPLE BLANCO
ROBLE ENTABLILLADO/ NATURAL / HERCULES/
TEXTIL TESSUTO
GRIS ALUMINIO
NOGAL CANALETO
LINO CANCUN
PINO CERVINO
SELENE GRIS
CEREZO LUNA

TIRA CANTEADA 2440*330*16mm
BLANCO SOFT
HAYA DAIMIEL
ROBLE ENTABLILLADO
GRIS ALUMINIO
CEREZO LUNA



TABLEX



TIRA CANTEADA 2530*1205*19mm
BLANCO SOFT
HAYA DAIMIEL
ROBLE ENTABLILLADO/ROBLE TGL
TEXTIL TESSUTO
LINO CANCUN
TIRA CANTEADA 2850*580*19mm 2850*670*19mm 2850*150*19mm SIN CANTEAR
HYBRYD SAND
HYBRID GREY

MODELO / MEDIDA	TABLEX CRUDO
- ALUMINIO-ROBLE URG 2440*1220*04mm	- 2440*1220*2.5mm
- BLANCO-GRISAZULADO 2400*1220*04mm	- 2440*1220*03mm
- BLANCO SOFT 2 CARAS 2440*1220*04mm	- 2440*1220*4.8mm
- BLANCO SOFT 2440*1220*03mm	
- BLANCO LIS-GRIS ALUMINIO 2440*1220*04mm	
- NOGAL CANALETTO -ROBLE ENTABLILLADO 2440*1220*04mm	
- PINO-ROBLE TRG 2440*1220*04mm	
- ROBLE ENTABLILLADO-CEREZO 2440*1220*04mm	
- ROBLE ENTABLILLADO-HAYA 2440*1220*04mm	
- ROBLE ENTABLILLADO-WENGUE 2440*1220*04mm	
- ROBLE RFO-BLANCO SOFT 2440*1220*03mm	
- ROBLE NATURAL- MAPLE BLANCO 2440*1220*04mm	
TABLEX SOPORTE DM	
- BLANCO 2440*1220*4mm	



I4. RECHAPADO Y CONTRACHAPADO

STOCK

TABLEROS RECHAPADOS CHAPA NATURAL:

Tablero de partículas de madera de formación en tres capas aglomerado con resinas sintéticas mediante prensado plano a alta temperatura y lijado. Calidad estándar 1ª/2ª Medidas 2440*1220.

CHAPA/GROSOR

- HAYA BLANCA 2440*1220*11mm
- HAYA BLANCA 2440*1220*4mm
- HAYA VAPORIZADA 2440*1220*4 / 11 / 16 / 19 / 30 mm
- ROBLE 2440*1220*4 / 11 / 16 / 19 mm
- SAPELLY 2440*1220*4/ 11/ 16 / 19 mm
- PINO VALSAIN 2440*122*04/11/16/19mm

CANTO

CANTOS SINTÉTICOS:

Disponemos en nuestros almacenes de cantos sintéticos para toda nuestra gama de stock en tableros de melamina.

Los cantos que tenemos en stock son de ancho 22mm y con la posibilidad de ser precolados o sin cola.



CANTOS PVC:

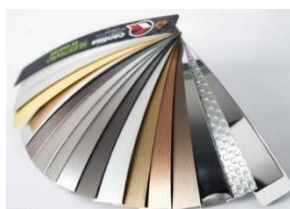

Los cantos de pvc que encontraran en nuestras instalaciones, van en espesores desde los 0.4mm, 0.8mm y 1mm. Nuestros anchos son de 22mm. Los modelos que tenemos disponibles van acordes con nuestra gama de melaminas, con la posibilidad de adquirir otro diseño bajo pedido.

CHAPA:



Las chapas que les ofrecemos para los nuestros tableros rechapados son de ancho 22mm y con la posibilidad de ser precolados o sin cola.

También encontrará chapas anchas con anchos de 240mm.



info@madeter.com
info@racaso.com

maderascasas@maderascasas.com

www.maderascasasteruel.com

CONTRACHAPADO ANTIDESLIZANTE “CARROCERÍAS”:

Toda la madera contrachapada, encolada con cola fenólica, una cara de deslizamiento está recubierta con una película fenólica con el panel marrón y liso en la cara trasera.

La base está hecha de madera contrachapada de abedul capa cruzada con las caras opciones II según la norma EN 635-2. Su densidad oscila entre 640 y 700 kg/m³.

Material INT. ABEDUL

- 2500*1525/1250*9mm
- 2500*1525/1250*12mm
- 2500*1525/1250*15mm
- 2500*1525/1250*18mm
- 2500*1525/1250*21mm
- 2500*1525/1250*30mm



Material INT. CHOPO

- 2500*1250*18mm
- 2500*1250*21mm
- 2500*1250*24mm



Nowaki Camper Panel

Te presentamos Nowaki Camper Panel: un tablero ultraligero específicamente pensado para la camperización.

Está hecho de madera de Paulownia, que tiene muchas ventajas para aplicaciones de mobiliario y revestimientos interiores. Tienes 9 diseños diferentes para personalizar tu furgoneta camper y disfrutar de las últimas tendencias en diseño de mobiliario.

- Panel ultraligero de madera natural de Paulownia con recubrimiento decorativo HPL.
- Formatos: 2440x1220x15 mm.
- Aplicaciones: Panelados, frentes y mobiliario.



Consultar Disponibilidad.



info@madeter.com
info@racaso.com

maderascasas@maderascasas.com



SOSTENIBLE: captura más CO2 que cualquier otra especie.



RESISTENTE A LA HUMEDAD Y PUTREFACCION: Aumenta la durabilidad y vida útil de mobiliario y revestimientos.



LIGERA: su densidad es inferior a los 300 kgs./m3. Más carga útil y menor consumo de combustible.



DE DIFÍCIL COMBUSTIÓN: material de difícil combustión. Ideal para base de puertas ignífugas.



AISLANTE: excelente comportamiento como aislante tanto térmico como acústico.



info@madeter.com
info@racaso.com

maderascasas@maderascasas.com

www.maderascasasteruel.com

CONTRACHAPADO CALABO:

- 2500*1220*03mm
- 2500*1220*04mm
- 2500*1220*05mm
- 2500*1220*07mm

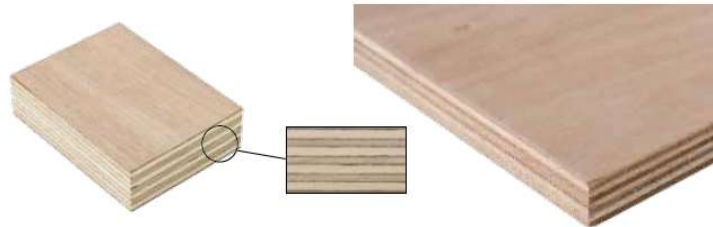

CONTRACHAPADO FENÓLICO:

- OKUMEN WBP 2500*1220*10mm
- OKUMEN WBP 2500*1220*12mm
- OKUMEN WBP 2500*1220*15mm
- OKUMEN WBP 2500*1220*18mm
- OKUMEN WBP 2500*1220*20mm



CONTRACHAPADO FENÓLICO ENCOFRAR CON FILM:

MATERIAL

- 2500*1250*18mm
- 2500*1250*21mm
- 2500*1250*24mm

CONTRACHAPADO FENÓLICO EMBALAJE C/C+ PINO ELIOTI:



MATERIAL

- 2500*1250*15mm
- 2440*1220*18mm

CONTRACHAPADO FENÓLICO ABEDUL:



MATERIAL

- 2500*1250*12 PANADERIA
- 2500*1250*15 BLANCO SOFT



I5.TABLERO ALISTONADO

TABLERO ALISTONADO PINO LAMA ENTERA:

STOCK

MATERIAL

- ENTERO RADIATA 2400*1220*22 mm
- ENTERO RADIATA A/A 2450*1220*18 mm
- ENTERO RADIATA A/AB 2400*1220*30 mm
- PINO C/C 3300*1220*15mm
- PINO ENTERO ROJO C/C 3600*1220*22
- INSIGNIS 1° A/B 2500*1220*40 mm



TABLERO ALISTONADO PINO FINGER



MATERIAL

- FINGER JOINT 2440*1220*22mm
- FINGER JOINT 2440*1220*30mm
- FINGER JOINT 2440*1220*18mm

TABLERO ALISTONADO ABETO MONOCAPA



MATERIAL

- 2750*1200*35mm
- 2500*1200*14mm
- 2750*1200*18mm
- 2750*1200*35mm



info@madeter.com
info@racaso.com

maderascasas@maderascasas.com

www.maderascasasteruel.com

TABLERO ALISTONADO ROBLE

MATERIAL

ROBLE 2500*320*20 mm PELDAÑOS
ROBLE 27mm varios largos y anchos
ROBLE FINGER 3300*1220*19mm
ROBLE FINGER 3300*1220*32mm
ROBLE FINGER 3300*1220*42mm



TABLERO ALISTONADO HAYA

MATERIAL

- HAYA VAPORIZADA 3000*1030*20 mm
 - HAYA VAPORIZADA 3000*1030*32mm
-



TABLERO ALISTONADO TRICAPA ABETO



MATERIAL

- ALISTONADO TRICAPA ABETO 19 mm
 - ALISTONADO TRICAPA ABETO 35mm
 - ALISTONADO TRICAPA ABETO 27 mm
-

TABLERO DE ENCOFRAR TRICAPA:



MATERIAL

- 2000*500*27mm
-



info@madeter.com
info@racaso.com

maderascasas@maderascasas.com

www.maderascasasteruel.com

TABLERO COMPACTO

COMPACMEL PLUS:

[Consultar Disponibilidad.](#)

DESCRIPCIÓN

Compacmel Plus es un tablero compacto de fibras de madera, recubierto con papel decorativo impregnado con resinas melamínicas.

CARACTERÍSTICAS

Su soporte ofrece un buen comportamiento en aplicaciones de interior que requieren una exposición en condiciones de humedad muy elevada y persistente en el tiempo.

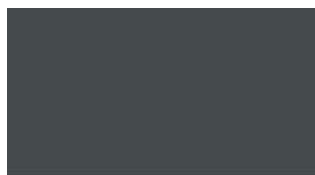

71A- GRIS GU
Soft III

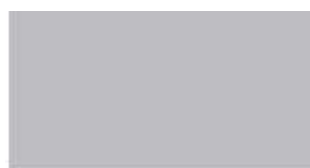

U12- NATURAL GREY
Soft III



139 AZUL EO
Soft III



78E- WHITE SR209
Soft III



info@madeter.com
info@racaso.com

maderascasas@maderascasas.com

www.maderascasasteruel.com

PLACAS PARA FACHADAS:

- Es una placa laminada compacta de alta presión (HPL) con una superficie decorativa integrada.
- Las placas Trespa® Meteon® son ideales para ser aplicadas en sistemas de fachadas ventiladas innovadoras y funcionales. Pueden determinar el aspecto y subrayar las calidades de un edificio.
- Las placas Trespa® Meteon® tienen un magnífico comportamiento en exteriores. Ni el sol, ni la lluvia afectan de manera significativa la superficie de la placa, siendo incluso prácticamente insensibles a la lluvia ácida.



PLACAS PARA BALCONES:

- Trespa Meteon es una placa laminada compacta de alta presión (HPL) con una superficie decorativa integrada, fabricada según la exclusiva tecnología patentada de descarga de electrones (EBC) de Trespa. La mezcla de hasta un 70% de fibras de madera y resinas termoendurecibles, sometidas a alta presión y temperaturas, permite obtener una placa extraordinariamente compacta con una buena relación resistencia-peso.



SOLUCIONES PARA LABORATORIOS:

- Trespa® TopLab® ofrece tres líneas de productos que combinan requerimientos básicos - higiene duradera de la superficie, resistencia al impacto y al rayado, flexibilidad y facilidad de uso - con cualidades estéticas que pueden contribuir a favorecer el bienestar de empleados y visitantes.

TRESPA® TOPLAB® PLUS

Antibacteriana y altamente resistente a las sustancias químicas



16. MARCOS

STOCK

PREMARCOS

PREMARCO MULTICABECERO		
Para puerta: 625/725/825	Medidas m/m	Premarcos Desmontados
	40*60*2040mm	
	40*70*2040mm	
	40*80*2040mm	
	40*90*2040mm	
	40*100*2040mm	
	40*110*2040mm	
	40*120*2040mm	
	40*130*2040mm	
	40*140*2040mm	
Para puerta: 1470	35*90*2040mm	



CERCOS DIRECTOS

	MARCOS DIRECTOS		
	Medidas m/m	Cabecero	
GALCE 35	70x57x2030	625	
		725	
		825	
	57x70x2030	625	
		725	
		825	
	57x90x2030	625	
		725	
		825	
	57x115x2030	625	
		725	
		825	
GALCE 45	70x90x2030	825	
	70x145x2030	825	

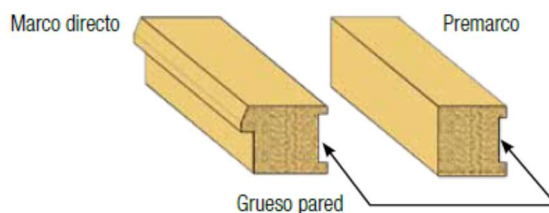

LARGUERO ALIST. ABETO

2700*60*40





ÚNICO Premarco que permite alojar una puerta corredera entre una hoja.

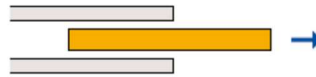

Consultar Disponibilidad.



EXTENSIÓN: Premarco que permite alojar dos puertas correderas, una a la derecha y otra a la izquierda del hueco abierto en la pared.

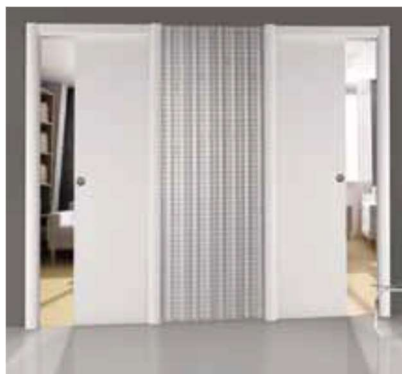

NOVANTA: Un único armazón central permite alojar dos puertas correderas

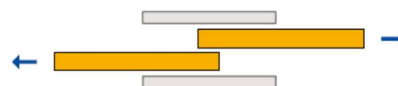

UNILATERAL: Eclipse circular esconde una hoja corredera empotrable curva. Permite reinterpretar la subdivisión de los espacios.



ARMAZONES PARA PUERTA CORREDERAS ECLISSE.

Stock Disponible:

STOCK

Material			
Armazones para enlucir con yeso	Medida puerta	Hueco	total
		ancho x alto	
600*2020/2100* 90/108	625	1315*2110	
700*2020/2100* 90/108	725	1515*2110	
800*2020/2100* 90/108	825	1715*2110	
900*2020/2100* 90/108	925	1915*2110	
1000*2020/2100* 90/108	1025	2115*2110	

VERSIÓN ENLUCIDO

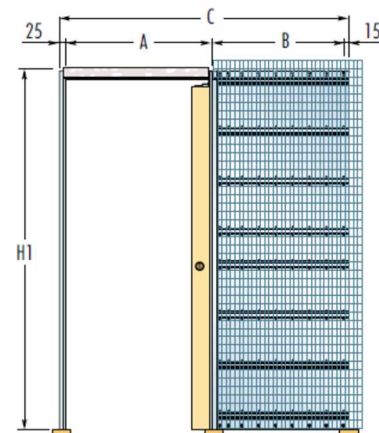
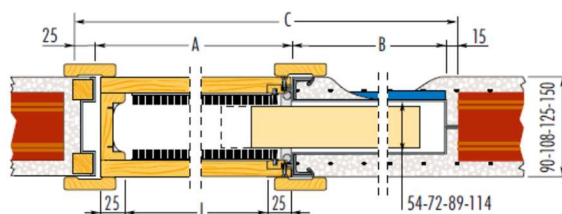

Material			
Armazones para cartón yeso	Medida puerta	Hueco	total
		ancho x alto	
600*2020* 100/125	625	1297*2105	
700*2020* 100/125	725	1497*2105	
800*2020* 100/125	825	1697*2105	
900*2020* 100/125	925	1897*2105	
1000*2020* 100/125	1025	2097*2105	

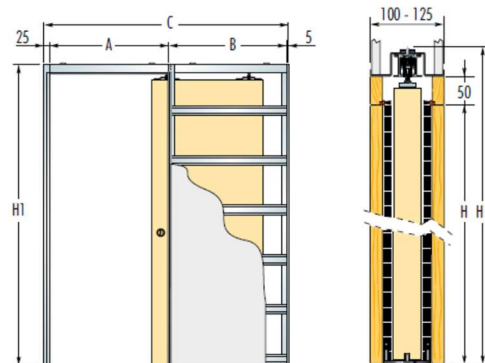

VERSIÓN CARTÓN YESO

PRELACADO	KIT 90
LACADO	KIT 110
SAPELY BARNIZADO S/B	
ROBLE BARNIZADO S/B	
HAYA BARNIZADO S/B	

ACCESORIOS ARMAZONES

KIT CORREDERAS MDF:



I 7. PUERTAS

STOCK



HAYA VAP



ROBLE

PUERTAS C/O
BARNIZADAS Y
SIN BARNIZAR

MEDIDA

PINO 2030*625/725/825*35

SAPELY 2030*625/725/825*35

ROBLE 2030*625/725/825*35

HAYA
VAP. 2030*625/725/825*35

PUERTA DM CRUDO 5 mm

CIEGA 2030*625*35

CIEGA 2030*725*35

CIEGA 2030*825*35

CIEGA 2030*925*35

CIEGA 2030*1000*35



SAPELY



PINO



info@madeter.com
info@racaso.com

maderascasas@maderascasas.com

www.maderascasasteruel.com

STOCK

puertas



V3

Fresado pico gorrión

V4

Fresado pico gorrión

F04
LACADA

catálogo



info@madeter.com
info@racaso.com

maderascasas@maderascasas.com

www.maderascasasteruel.com



LISA LACADA



V1

V4

H04 LACADA



V3

Fresado pico gorrón

V4

Fresado pico gorrón



info@madeter.com
info@racaso.com

maderascasas@maderascasas.com

www.maderascasasteruel.com



H00 LACADA



F02
LACADA



V3

Fresado pico gorrón



V4

Fresado pico gorrón

catálogo



info@madeter.com
info@racaso.com

maderascasas@maderascasas.com

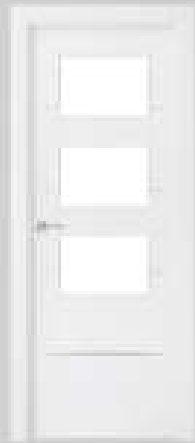

21513

LACADO BLANCO



LACADO BLANCO

21500



info@madeter.com
info@racaso.com

maderascasas@maderascasas.com

www.maderascasasteruel.com



20101
LACADO BLANCO



LACADO BLANCO 20100



info@madeter.com
info@racaso.com

maderascasas@maderascasas.com

www.maderascasasteruel.com



216

LACADO BLANCO



LACADO BLANCO 212



info@madeter.com
info@racaso.com

maderascasas@maderascasas.com

www.maderascasasteruel.com



3203
LACADO BLANCO



LACADO BLANCO 3212



info@madeter.com
info@racaso.com

maderascasas@maderascasas.com

www.maderascasasteruel.com



Puerta Lisa Melamina veta horizontal

**ROVERE
GRIGIO**



Puerta Lisa Melamina veta horizontal

**LEGNO
GREY**



info@madeter.com
info@racaso.com

maderascasas@maderascasas.com

www.maderascasasteruel.com



LISA

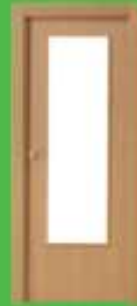

V1

Roble
Haya vaporizada
Sapelly
Pino país

V3

Roble
Haya vaporizada

V4

Roble
Haya vaporizada



V3

Roble

V4

Roble

DECO TS



info@madeter.com
info@racaso.com

maderascasas@maderascasas.com

www.maderascasasteruel.com



V4
 Roble
 Fresado pico gorrón
H00



V3
 Roble
 Haya vaporizada
 Fresado pico gorrón



V4
 Roble
 Haya vaporizada
 Fresado pico gorrón



F04



info@madeter.com
info@racaso.com

maderascasas@maderascasas.com

www.maderascasasteruel.com



V4

Roble
Fresado pico gorrión

H04

ROBLE



catálogo



info@madeter.com
info@racaso.com

maderascasas@maderascasas.com

www.maderascasasteruel.com

HERRAJES Y COMPLEMENTOS



MANIVELA MOD. R130

Producto: Roseta
Material: Zamak-Aluminio
Acabado: Níquel Satinado



MANIVELA MOD. R1403

Producto: Roseta
Material: Acero Inoxidable
Acabado: Acero Inoxidable



MANIVELA MOD. R430

Producto: Roseta
Material: Zamak-Aluminio
Acabado: Níquel Combinado



MANIVELA MOD. RC530

Producto: Roseta
Material: Aluminio
Acabado: Níquel Satinado



MANIVELA MOD. RC240

Producto: Roseta
Material: Zamak-Aluminio
Acabado: Níquel Combinado



MANIVELA MOD. RC220

Producto: Roseta
Material: Zamak
Acabado: Níquel Combinado



CERRADURA
MOD. KIT 2003

Producto: Cerradura puerta
corredera entrada 50mm,
uñero con condena y seguro
Acabado: Níquel Satinado



TIRADOR UÑERO KIT

Producto: Tirador uñero
lateral redondo para
embutir pasante para
puerta corredera
Acabado: Níquel Satinado



Pol. Malpica, C/ F (oeste) 15 - 16
50016 Zaragoza
Telf. 876 010 639
info@racaso.com
www.racaso.com

Sigue nuestras Redes Sociales

Maderas Casas Alcorisa

MaderasCasasAlcorisa
 @maderas_casas_alcorisa

Maderas Casas Teruel

maderasteruel22
 @maderas_teruel

Maderas Racaso

MaderasRacaso
 @maderas_racaso



Telf. 978 84 00 79



Telf. 978 61 83 20



Telf. 876 010 942



info@madeter.com
info@racaso.com

maderascasas@maderascasas.com

PUERTAS MACIZAS

Consultar Disponibilidad.

PUERTAS ENTRADA SERIE 200



MODELO E214



MODELO E215



MODELO E216



MODELO E217



info@madeter.com
info@racaso.com

maderascasas@maderascasas.com

www.maderascasasteruel.com



MODELO E311



MODELO E317



MODELO E315



MODELO E307



MODELO E304



MODELO E305





MODELO E401



MODELO E402



MODELO E409



MODELO E414



MODELO E411





MODELO P501



MODELO P506



MODELO P513



MODELO P504



MODELO P510



MODELO P512

DISPONIBILIDAD DE CATALOGO
COMPLETO EN PDF



info@madeter.com
info@racaso.com

maderascasas@maderascasas.com

www.maderascasasteruel.com

SERIE LAMINADOS alternativas a la madera natural.

Consultar Disponibilidad.

Soluciones constructivas para cada proyecto. Las puertas DAYFOR pueden asumir y adaptarse a los diversos tipos de construcción permitiendo a los prescriptores arquitectos y decoradores, la posibilidad de aunar bajo un mismo aspecto todo el conjunto de la obra, los fabricados del Grupo, ofrecen al mercado una solución práctica, con la posibilidad de fabricar tanto las puertas de paso, entrada, resistentes al fuego, armarios etc. en los mismos acabados y con un aspecto estético unificado. Dentro de la gama de laminados trabajamos con todos los tipos tanto de baja, media y alta presión, LPL, CPL, HPL.

LAMINADO DE ALTA PRESIÓN – HPL

Centros de salud



 Puertas y paneles en laminado alta presión Formica Digiform® con diseño especial para esta obra realizados por la dirección facultativa.

LAMINADO DE BAJA PRESIÓN - MELAMINA

Hospitales



 Carpintería especial para centros hospitalarios compuesta por puertas y paneles en laminado baja presión - color haya y cercos aluminio.



info@madeter.com
info@racaso.com

maderascasas@maderascasas.com

www.maderascasasteruel.com

PUERTAS PLEGABLES PVC

Consultar Disponibilidad.

Se trata de puertas fabricadas en PVC de alta calidad, serigrafadas en cuatricromía y lacadas.

Colores disponibles

SERIE VINILO



MODELO BERNA



MODELO NIZA



info@madeter.com
info@racaso.com

maderascasas@maderascasas.com

La extensa gama de la colección que está realizada íntegramente en madera contrachapada natural barnizada y con sus componentes en madera maciza.

SERIE MADERA NATURAL

Colores disponibles



Lacado
Blanco



Roble



Sapelly

MODELO MILÁN



MODELO SIENA



info@madeter.com
info@racaso.com

maderascasas@maderascasas.com

Consultar Disponibilidad.

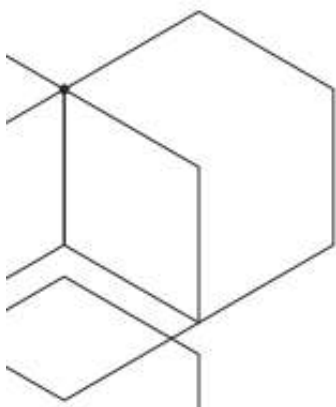

PUERTAS DE ALUMINIO

PORTES EN ALUMINIUM



info@madeter.com
info@racaso.com

maderascasas@maderascasas.com

- 1.** La puerta de aluminio STRUGAL no se hinchan por efecto de la humedad ni se deterioran por el contacto del agua.
- 2.** Son más resistentes al paso del tiempo. No se estropean ni descomponen.
- 3.** Se limpian fácilmente.
- 4.** Fáciles de montar y desmontar por cualquier usuario, sin que se requiera conocimientos profesionales.
- 5.** Se pueden colocar tanto en premarcos de aluminio como de madera.
- 6.** Pueden ajustarse fácilmente a las posibles dilataciones de la obra o del premarco.
- 7.** Permiten un diseño totalmente personalizado.
- 8.** Son inmunes a los microorganismos: las puertas de aluminio STRUGAL son 100% resistentes a la carcoma, las termitas y cualquier insecto.
- 9.** Los tapajuntas son muy fáciles de quitar y poner a la hora de pintar.
- 10.** Se pueden suministrar con acabado antibacteriano.
- 11.** Son respetuosas con el medio ambiente. Las ventajas que presentan en términos de aislamiento, mejoran la eficiencia energética de la vivienda y contribuyen a la reducción de CO₂.
- 12.** Por las propiedades del aluminio, ofrecen un notable incremento en seguridad.



info@madeter.com
info@racaso.com

maderascasas@maderascasas.com

PUERTAS DE INTERIOR

Colección lisa



STRUGAL A 100 C



STRUGAL A 100 OB



STRUGAL A 100 3VE



STRUGAL A 100 4VE



STRUGAL A 100 1VEL



STRUGAL A 100 1VAL



STRUGAL A 100 3VA



STRUGAL A 100 4VA



ACABADOS STOCK. ACABAMENTOS STOCK.

Ver disponibilidad. Ver disponibilidad.



info@madeter.com
info@racaso.com

maderascasas@maderascasas.com

www.maderascasasteruel.com

PUERTAS DE INTERIOR

Colección fresada



STRUGAL
A 200 4FH1



STRUGAL
A 200 4FH1/V



STRUGAL
A 200 2FH



STRUGAL
A 200 2FH/V



STRUGAL
A 200 4FH2



STRUGAL
A 200 4FH2/V



STRUGAL
A 200 2FV



STRUGAL
A 200 2FV/V



STRUGAL
A 200 2FH1FV



STRUGAL
A 200 2FH1FV/V



STRUGAL
A 200 4FH2FV



STRUGAL
A 200 4FH1/4V



STRUGAL
A 200 2PF



STRUGAL
A 200 2PF/V



STRUGAL
A 200 FV



STRUGAL F 100 C
STRUGAL F 100 C/V



ACABADOS STOCK. ACABAMENTOS STOCK.

Ver disponibilidad. Ver disponibilidad.



info@madeter.com
info@racaso.com

maderascasas@maderascasas.com

www.maderascasasteruel.com

PUERTAS DE INTERIOR

Colección incrustación de aluminio



STRUGAL A 300 2IH1



STRUGAL A 300 2IH1/V



STRUGAL A 300 2IV



STRUGAL A 300 2IV/V



STRUGAL A 300 4IH1



STRUGAL A 300 4IH1/V



STRUGAL A 300 4IH2



STRUGAL A 300 4IH2/V



STRUGAL F 100 C
STRUGAL F 100 C/V



info@madeter.com
info@racaso.com

maderascasas@maderascasas.com

www.maderascasasteruel.com

PUERTAS DE EXTERIOR

Colección lisa, fresada e incrustación de aluminio



STRUGAL A 400 C



STRUGAL A 400 4H



STRUGAL A 400 2H



STRUGAL A 400 6H



STRUGAL A 400 6H2V



STRUGAL A 400 2V1



STRUGAL A 400 2V2



STRUGAL A 400 2H1V



STRUGAL A 400 4V



STRUGAL F400C STRUGAL F400 2H

Fresado Fresagen Incrustación Incrustação



* Incrustación fuera de stock. Incrustação fuera de stock.



ACABADOS STOCK. ACABAMENTOS STOCK. Ver disponibilidad. Ver disponibilidad.



info@madeter.com
info@racaso.com

maderascasas@maderascasas.com

www.maderascasasteruel.com

PUERTAS DE EXTERIOR

Colección duelas



STRUGAL A 500 D1



STRUGAL A 500 D2



STRUGAL A 500 D3



STRUGAL F
500 C



STRUGAL F
500



STRUGAL F
500 3V2

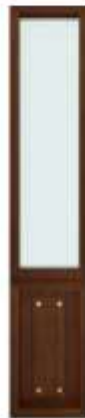

STRUGAL F
500 1V2



STRUGAL F
500 1V



STRUGAL F
500 1DIV



STRUGAL F
500 2DIV



STRUGAL F
500 3DIV



STRUGAL F
500 4DIV



STRUGAL F
500 5DIV



STRUGAL F
500 6DIV



info@madeter.com
info@racaso.com

maderascasas@maderascasas.com

www.maderascasasteruel.com

PUERTAS DE EXTERIOR

Colección vidrio



STRUGAL A 600 1VEL



STRUGAL A 600 2VEL



STRUGAL A 600 3VE



STRUGAL A 600 5VE



STRUGAL A 600 3VA



STRUGAL A 600 4VE

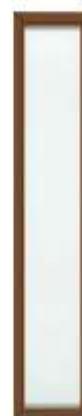

STRUGAL A
600 FIVA



STRUGAL A
600 1DIV



STRUGAL A
600 2DIV



STRUGAL A
600 3DIV



STRUGAL A
600 4DIV



STRUGAL A
600 5DIV



STRUGAL A
600 6DIV



info@madeter.com
info@racaso.com

maderascasas@maderascasas.com

www.maderascasasteruel.com

SPARTA 5

SÓLIDA ROBUSTA Y SEGURA

Consultar Disponibilidad.



ASSO 8

FUNCIONALIDAD CON CERRADURA DE SERVICIO



info@madeter.com
info@racaso.com

maderascasas@maderascasas.com

ASSO 10

LA PUERTA IDEAL PARA LA REFORMA



SYNERGY

MÁXIMA COMBINACIÓN DE PRESTACIONES



**AISLAMIENTO
TÉRMICO**
hasta 1,4w/m2K*

**RESISTENCIA A
LA EFRACCIÓN**
Clase 3
opcional Clase 4



**ABATIMIENTO
ACÚSTICO**
45 Db

**RESISTENCIA
AL FUEGO**
E12-30/60/90 en
una y dos hojas



* valores con revestimiento de 7mm (no aluminio)



info@madeter.com
info@racaso.com

maderascasas@maderascasas.com



Consultar Disponibilidad.

SISTEMA OUTLINE



info@madeter.com
info@racaso.com

maderascasas@maderascasas.com

www.maderascasasteruel.com

OUTLINE

CORREDERA

- Alto máximo de puerta 2700 mm
- Ancho máximo de puerta 1500 mm
- Espesores de cristal admisibles: 6, 8 y 10 mm
- Peso máximo del puerta 80 kg
- Uso con carriles y jgo. de carros Slide 80 retrack
- Ajustable en altura ± 3 mm.
- Maximum panel height 2700 mm
- Maximum panel width 1500 mm.
- Permissible glass thickness: 6, 8 and 10mm
- Maximum door weight 80 kg
- To use with running track and wheel set Slide 80 retrack
- Vertical adjustment ± 3 mm

Juego Outline 1P corredera 2700x1500

Kit Outline 1 Sliding door 2700x1500



Juego tiradores adhesivos cristal

Kit glass adhesive handles



Perfil horizontal Outline

Horizontal profile Outline

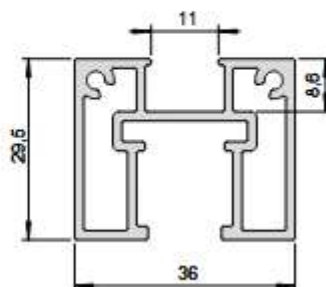

Perfil vertical outline

Vertical profile Outline

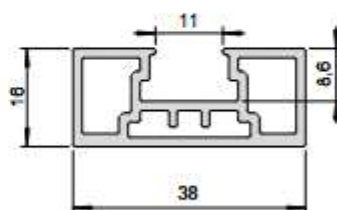

info@madeter.com
info@racaso.com

maderascasas@maderascasas.com

SLIDE 80

Sistema Slide retrac

Slide Retrac system

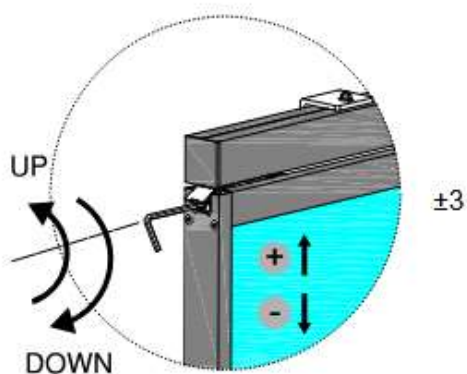
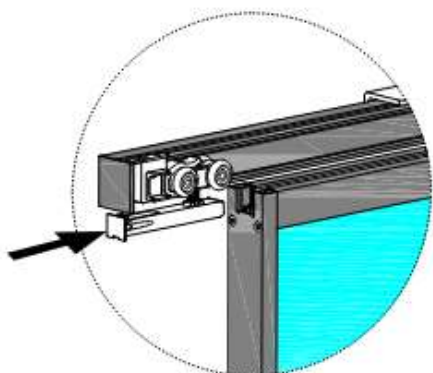

Juego carros para una puerta de madera con cierre suave

Wheel set for a wooden door with soft closing



- Dispositivo cierre suave bidireccional
- Bidirectional soft closing



Carril Slide 80 Flat

Running track Slide 80 Flat



Carril Slide 80 Ras

Running track Slide 80 Ras



info@madeter.com
info@racaso.com

maderascasas@maderascasas.com

www.maderascasasteruel.com



Consultar Disponibilidad.

Hidden



info@madeter.com
info@racaso.com

maderascasas@maderascasas.com

www.maderascasasteruel.com

HIDDEN

MARCO PARED REVOQUE / FRAME PLASTER WALL



Aluminio
Aluminium

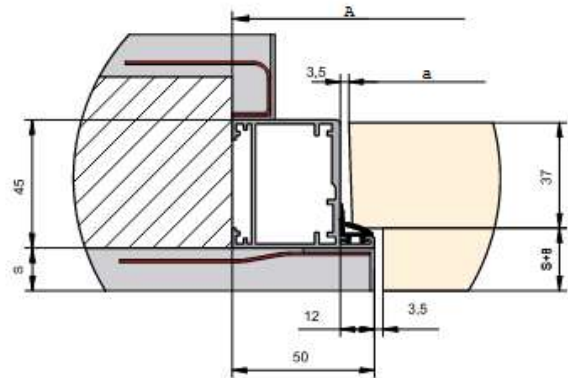

MARCO PARED PYL / FRAME DRYWALL

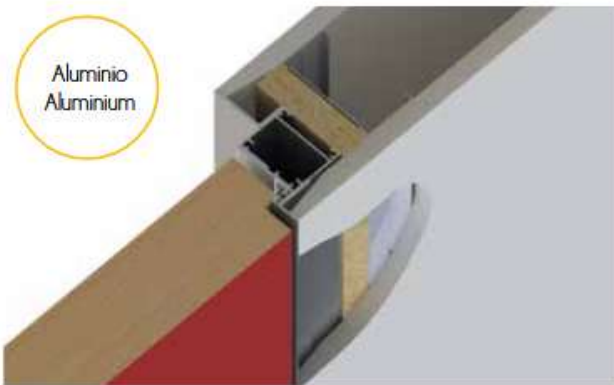

Aluminio
Aluminium

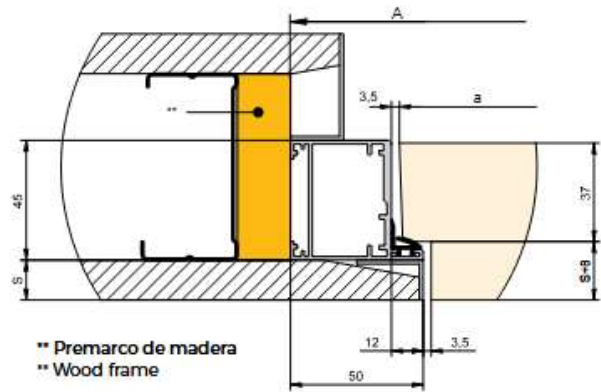

MARCO PARED REVOQUE APERTURA EXTERIOR / FRAME PLASTER WALL OUTWARDS



Aluminio
Aluminium

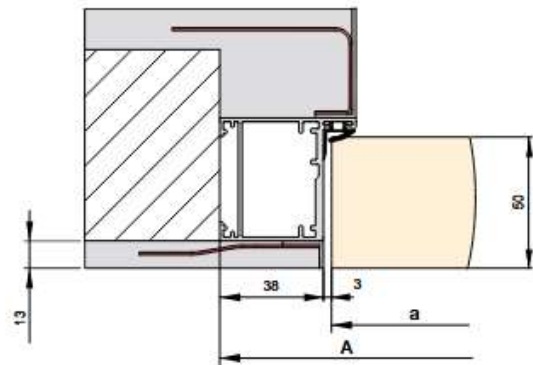

info@madeter.com
info@racaso.com

maderascasas@maderascasas.com

MARCO PARED PYL APERTURA EXTERIOR / FRAME DRYWALL OUTWARDS



Aluminio
Aluminium

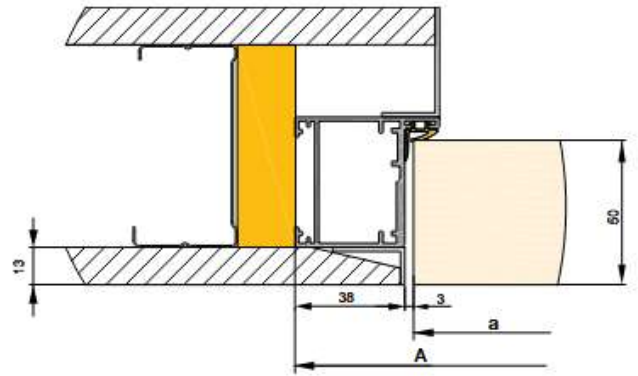

MARCO PARED PANELADA / FRAME PANELED WALL



Aluminio
Aluminium

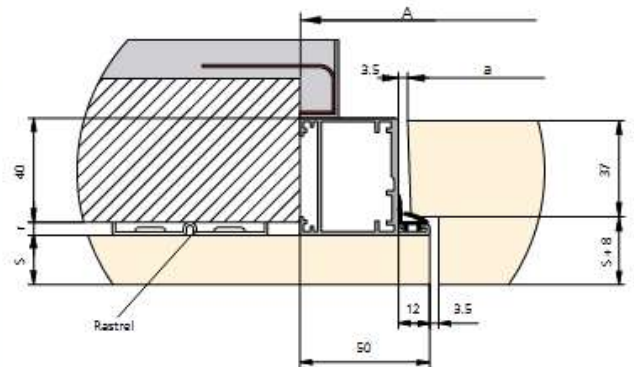

MARCO TELESCOPICO PARED PANELADA / TELESCOPIC FRAME PANELED WALL



Aluminio
Aluminium

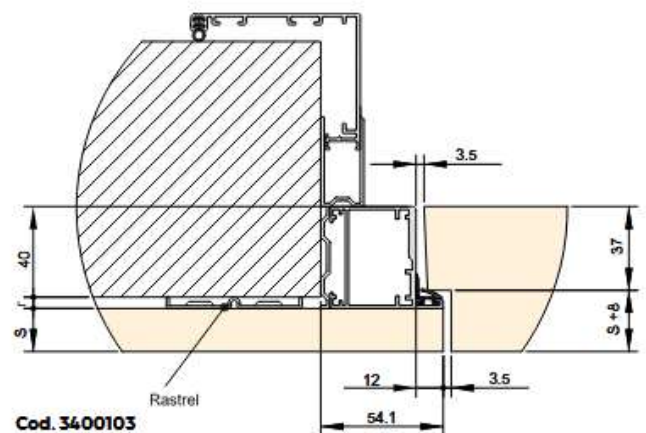

Cod. 3400103

Ver Capítulo 3.
See Chapter 3.



info@madeter.com
info@racaso.com

maderascasas@maderascasas.com

HIDDEN-45

Datos técnicos - Hidden45

Technical Data - Hidden45

Cerco de aluminio.

- Sencilla unión de los perfiles por medio de 2 escuadras.
- Bisagra oculta con regulación 3D.
- Acabado: anodizado plata mate y lacado blanco RAL 9016 Mate.
- Disponible en versión suelo techo.
- Opción con cierrapuertas oculto.
- Opción con apertura pivotante.
- Embalaje individual.

Puerta Opcional.

- Puerta realizada con MDF de 10mm en ambas caras, con alma de poliestireno expandido de alta densidad, perimetrada de pino alistonado.
- Disponible en crudo (denominamos MDF natural) y lacado blanco.

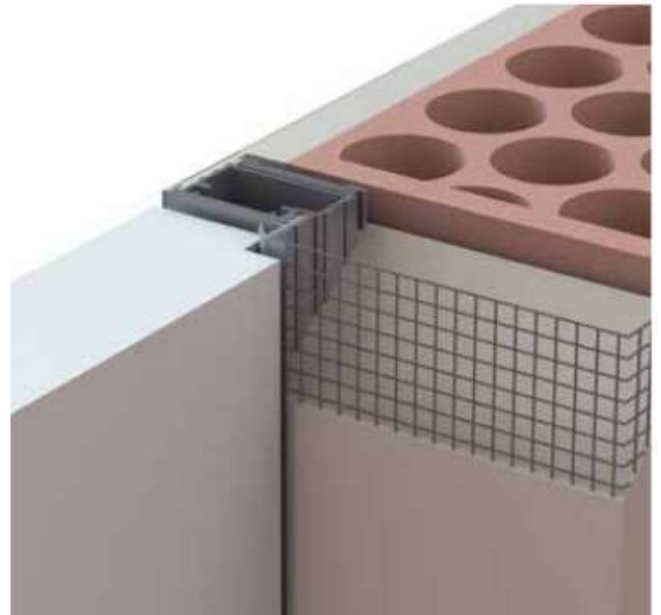
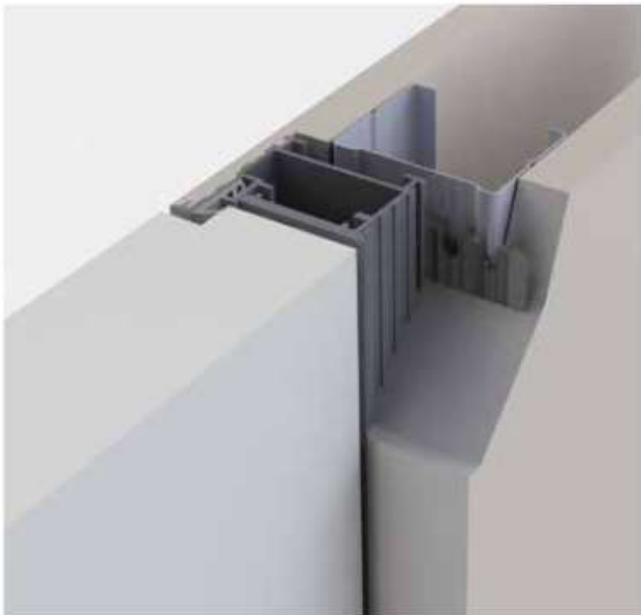

info@madeter.com
info@racaso.com

maderascasas@maderascasas.com

www.maderascasasteruel.com

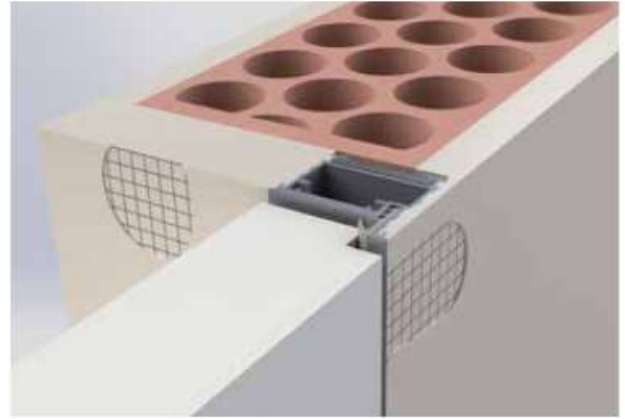

- Enrasable por ambas caras.
- Fabricado a medida.
- Sencilla unión de los perfiles por medio de 2 escuadras.
- Bisagra oculta con regulación 3D, para puertas de 40Kg, 60Kg o 80Kg.
- Malla de fibra de vidrio, resistente a la humedad, incluida.
- Acabado: anodizado plata mate o lacado blanco RAL 9016 Mate.
- Disponible en versión suelo techo.
- Opción con cierrapuertas oculto.
- Disponible en versión apertura pivotante.

PYL / Drywall

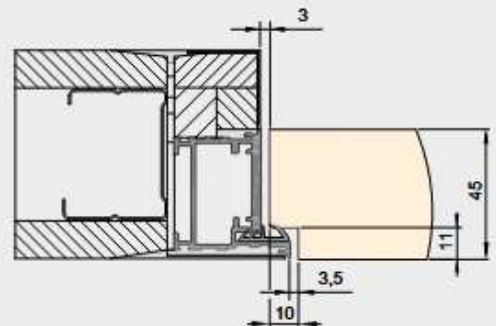
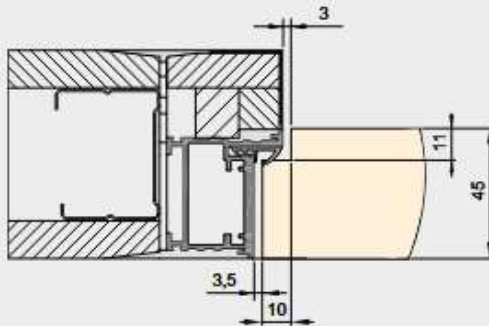

Revoque / Plaste wall

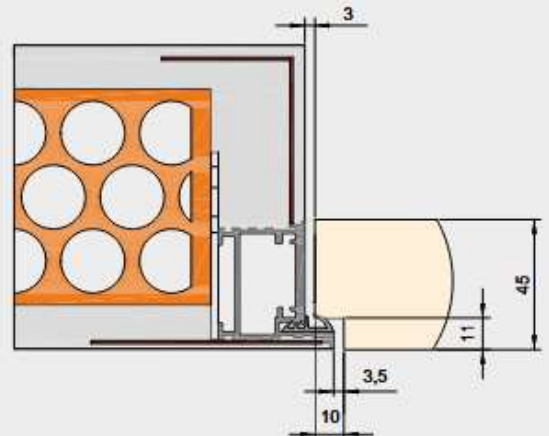
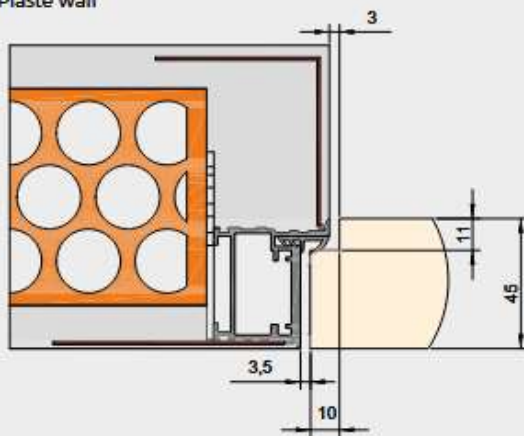



R-130



RI 403



RCC 220



R-430



RCC 120



RI 2025



3003



ROSETA CUADRADA
MANILLON Mod.RC534



ROSETA CUADRADA
MINILLON MOD RC244



KIT UÑERO PICAPORTE
KIT 2003I INOX
KIT 2003L LATÓN
KIT 2003I INOX CUADRADO



KIT TIRADOR UÑERO
KITI INOX
KITL LATÓN
KITCI INOX CUADRADO



18.ARMARIOS



www.maderascasasteruel.com

Catálogo de armarios
modulares y a medida

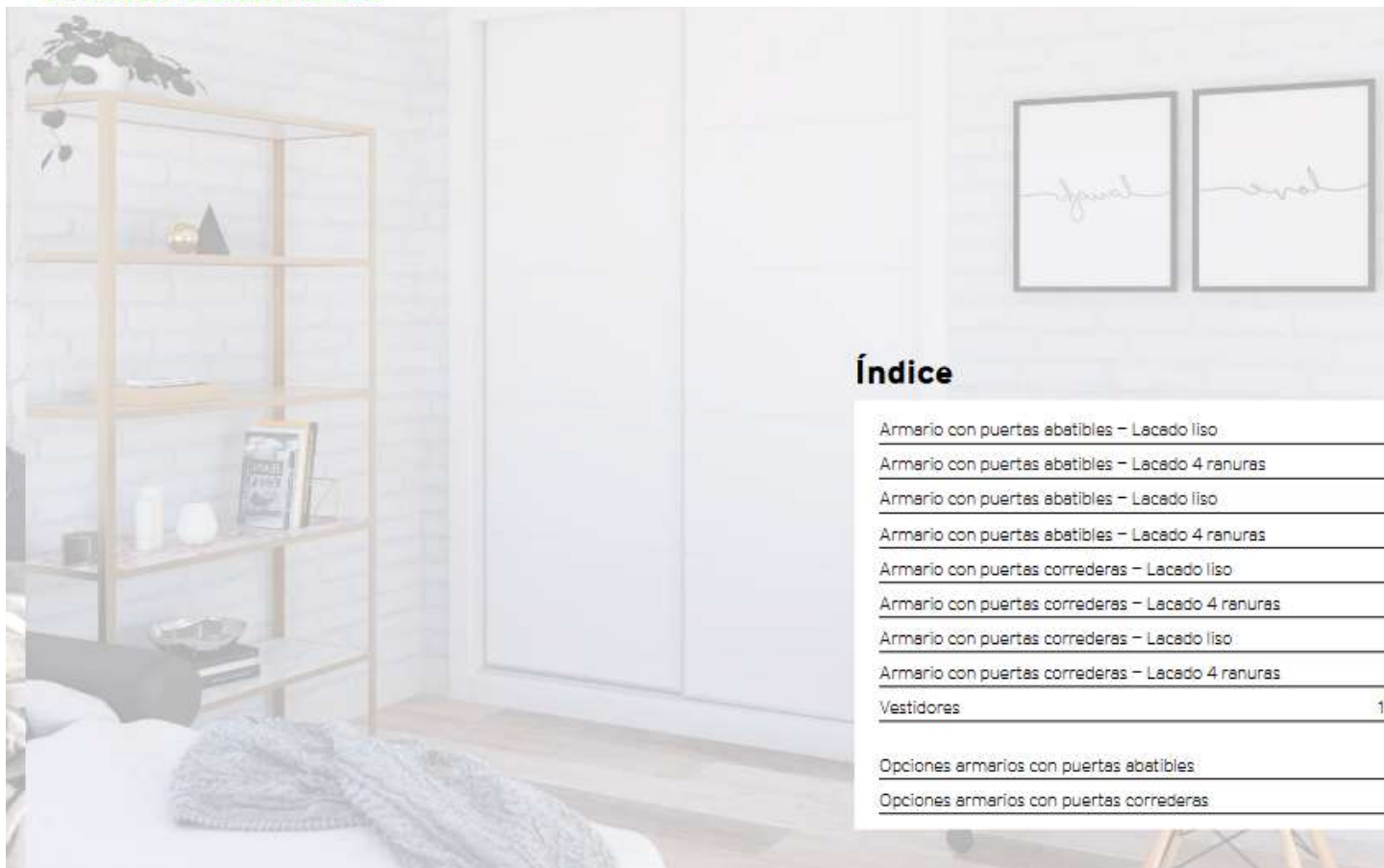

Índice

Armario con puertas abatibles – Lacado liso	
Armario con puertas abatibles – Lacado 4 ranuras	
Armario con puertas abatibles – Lacado liso	
Armario con puertas abatibles – Lacado 4 ranuras	
Armario con puertas correderas – Lacado liso	
Armario con puertas correderas – Lacado 4 ranuras	
Armario con puertas correderas – Lacado liso	
Armario con puertas correderas – Lacado 4 ranuras	
Vestidores	12
Opciones armarios con puertas abatibles	
Opciones armarios con puertas correderas	



info@madeter.com
info@racaso.com

maderascasas@maderascasas.com

www.maderascasasteruel.com



Armario con puertas abatibles

Lacado liso

Composición:

- Módulos abatibles de 1000 mm
- Hojas de armario abatible de 500 mm
- Costados decorativos
- Zócalo

Opciones:

- Módulos abatibles de 400 / 500 / 800 / 1000 mm
- Hojas de 400 / 500 mm

Ver todas las posibles combinaciones y opciones en las páginas 14 y 15.

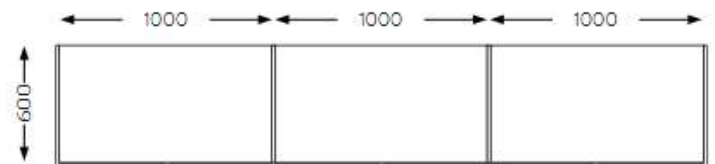
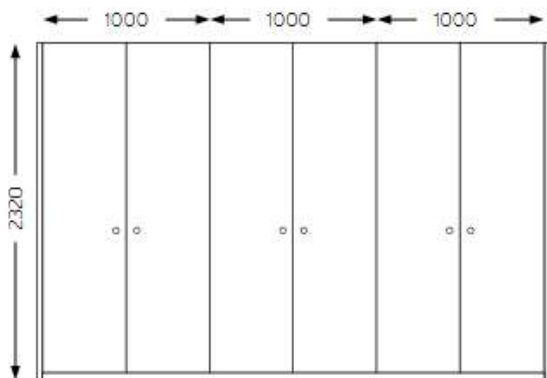

info@madeter.com
info@racaso.com

maderascasas@maderascasas.com



Armario con puertas abatibles

Lacado 4 ranuras

Composición:

- Módulos abatibles de 1000 mm
- Hojas de armario abatible de 500 mm
- Balda maletero
- Barra de colgar
- Tira iluminación LED
- Cajonera de 4 cajones de 450 mm
- Tapajuntas, montante y zócalo

Opciones:

- Módulos abatibles de 400 / 500 / 800 / 1000 mm
- Hojas de 400 / 500 mm

Ver todas las posibles combinaciones y opciones en las páginas 14 y 15.

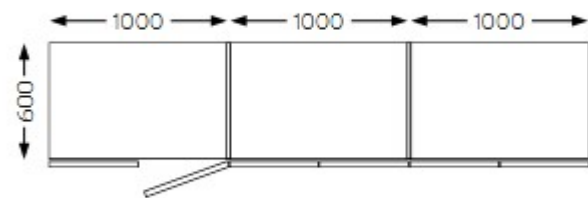
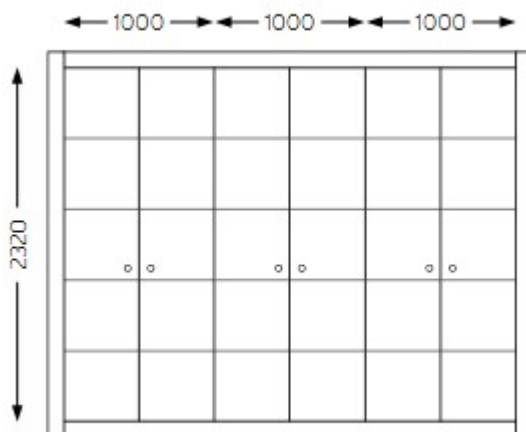

info@madeter.com
info@racaso.com

maderascasas@maderascasas.com

www.maderascasasteruel.com



Armario con puertas abatibles

Lacado liso

Composición:

- Módulos abatibles de 800 mm
- Hojas de armario abatible de 400 mm
- Tapajuntas, montante y zócalo

Opciones:

- Módulos abatibles de 400 / 500 / 800 / 1000 mm
- Hojas de 400 / 500 mm

Ver todas las posibles combinaciones y opciones en las páginas 14 y 15.

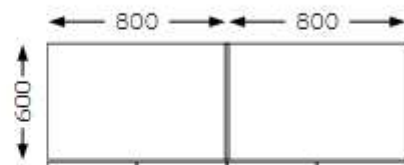
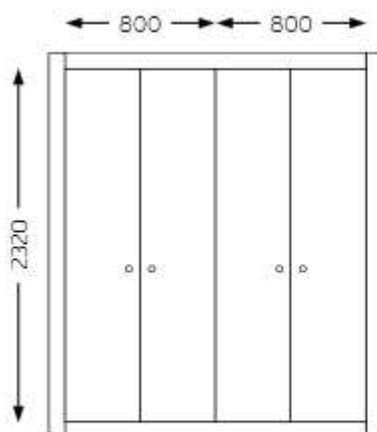

info@madeter.com
info@racaso.com

maderascasas@maderascasas.com

www.maderascasasteruel.com

100



Armario con puertas abatibles

Lacado 4 ranuras

Composición:

- Módulos abatibles de 1000 mm
- Hojas de armario abatible de 500 mm
- Costados decorativos
- Zócalo

Opciones:

- Módulos abatibles de 400 / 500 / 800 / 1000 mm
- Hojas de 400 / 500 mm

Ver todas las posibles combinaciones y opciones en las páginas 14 y 15.

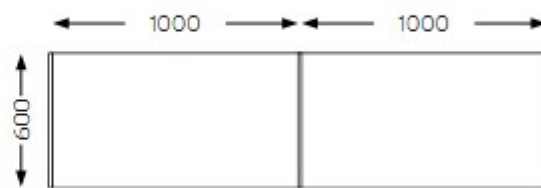
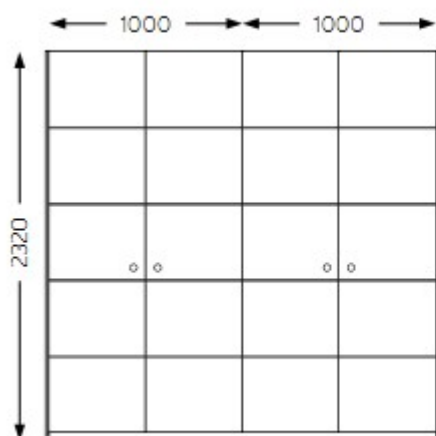

info@madeter.com
info@racaso.com

maderascasas@maderascasas.com

www.maderascasasteruel.com



Armario con puertas correderas

Lacado liso

Composición:

- Módulo corredera de 2400 mm
- Hojas de armario corredera de 800 mm
- Balda maletero y baldas estantes
- Tapajuntas, tapeta lateral de cierre, montante y zócalo

Opciones:

- Módulos corredera de 1600 / 2000 / 2400 mm
- Hojas de 800 / 1000 mm

Ver todas las posibles combinaciones y opciones en las páginas 14 y 15.

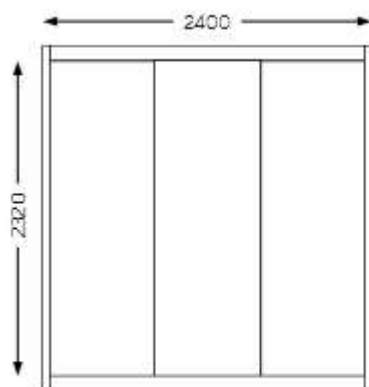

info@madeter.com
info@racaso.com

maderascasas@maderascasas.com

www.maderascasasteruel.com



Armario con puertas correderas

Lacado 4 ranuras

Composición:

- Módulo corredera de 2400 mm
- Hojas de armario corredera de 800 mm
- Tapetas laterales de cierre, montante y zócalo
- Costados decorativos con tapetas especiales

Opciones:

- Módulos corredera de 1600 / 2000 / 2400 mm
- Hojas de 800 / 1000 mm

Ver todas las posibles combinaciones y opciones en las páginas 14 y 15.

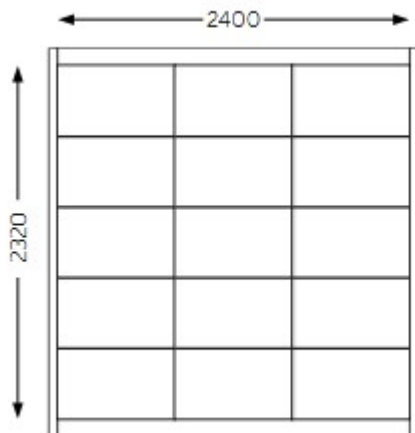

info@madeter.com
info@racaso.com

maderascasas@maderascasas.com

www.maderascasasteruel.com



Armario con puertas correderas

Lacado 4 ranuras

Composición:

- Módulo corredera de 1600 mm
- Hojas de armario corredera de 800 mm
- Tapajuntas, tapeta lateral de cierre, montante y zócalo

Opciones:

- Módulos corredera de 1600 / 2000 / 2400 mm
- Hojas de 800 / 1000 mm

Ver todas las posibles combinaciones y opciones en las páginas 14 y 15.

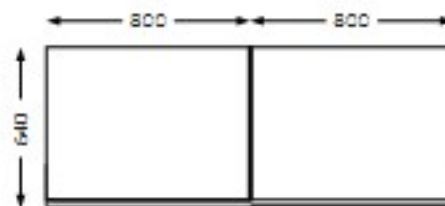
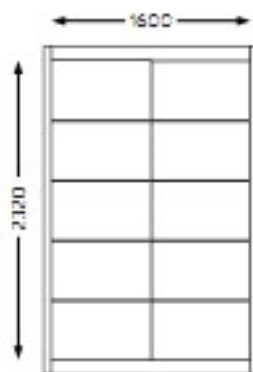

info@madeter.com
info@racaso.com

maderascasas@maderascasas.com

www.maderascasasteruel.com

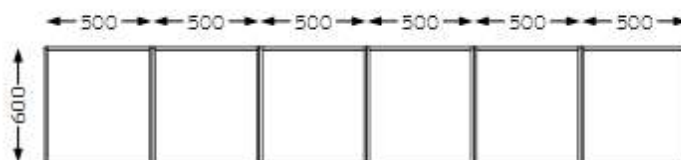
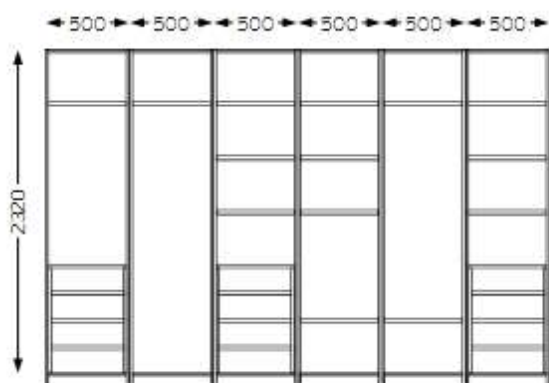

info@madeter.com
info@racaso.com

maderascasas@maderascasas.com

www.maderascasasteruel.com



Vestidor

Composición:

- Módulos de 800 mm
- Cajonera 4 cajones de 700 mm
- Baldas maletero y baldas estantes
- Divisor vertical
- Barras de colgar

Opciones:

- Módulos de 400 / 500 / 800 / 1000 mm
- Hojas de 400 / 500 mm

Ver todas las posibles combinaciones y opciones en las páginas 14 y 15.

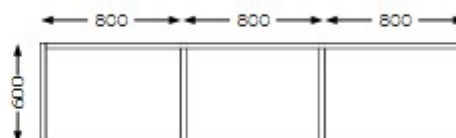

info@madeter.com
info@racaso.com

maderascasas@maderascasas.com

www.maderascasasteruel.com

Armarios Corredera

Sistema de puertas deslizantes, su principal ventaja es el ahorro de espacio en la apertura de las puertas. Disponible en dos y tres carriles, este último además, facilita el acceso al interior gracias a la apertura frontal en 2/3 de la superficie total de los paneles, permitiendo el aprovechamiento al máximo del espacio interior.



Armarios Abatibles

El sistema tradicional de apertura es un clásico actualizado gracias a un sinfín de diseños, con perfilera encuadrando la puerta o sin ella para acentuar la belleza de los acabados, se encuentra disponible en dos espesores: 16mm y 19mm.



Interiores de Armarios

Es aquí donde cada usuario debe elegir la distribución que mejor se adapte a su forma de sentir el orden, por nuestra parte le facilitamos la posibilidad de hacer realidad cualquier fantasía y de dotarla, a la vez, de la belleza que aporta una amplia gama de acabados.



PERFILERÍA Y COMPLEMENTOS DE ALUMINIO PARA ARMARIOS:

Stock Disponible:

STOCK

CORREDERO KIT GUIAS	DISEÑOS		€/und	€/und
				2 metros
	HAYA Sin Barnizar			
	PINO Sin Barnizar			
	ROBLE Sin Barnizar			
	BLANCO CHAMONIX			
	NEGRO MATE			
	PLATA MATE			



composición del kit de puerta:

- 2 ruedas inferiores
- 2 ruedas superiores
- tornillería varia
- cepillo
- 2 perfiles tiradores (2 x 2,6 m)
- 1 perfil horizontal (superior / inferior) (1 x 2 m)
- *tablero no incluido

KIT TIRADOR. KP-TR	BLANCO CHAMONIX
	NEGRO MOKKA
10mm (MIN)	PLATA MATE

KIT TIRADOR. KP-TR 10mm	PLATA MATE
----------------------------	------------

KIT TIRADOR. KP-TR	BLANCO CHAMONIX
	NEGRO MOKKA
16mm (MIN)	PLATA MATE

KIT TIRADOR. KP-TR	PINO sin barnizar
	ROBLE sin barnizar
16mm	PLATA MATE
	HAYA sin barnizar



info@madeter.com
info@racaso.com

maderascasas@maderascasas.com

www.maderascasasteruel.com

PERFILERÍA Y COMPLEMENTOS DE ALUMINIO PARA ARMARIOS:

Stock Disponible:



FRENO METAL CARRIL BAJO



ANCLAJE CARRIL BAJO



CEPILLO 10mm NEGRO ml

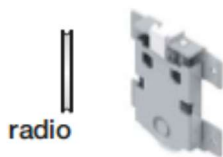

**CARRO INFERIOR
DIAM.30 C/RADIO**



**CARRO INFERIOR
DIAM.60 C/RADIO**



**CARRO INFERIOR RI
DIAM.60 C / DIENTE**



CARRO SUPERIOR S75



CARRO SUPERIOR MUELLE 2R S75

KIT 2 RETENEDORES AUTOCIERRE

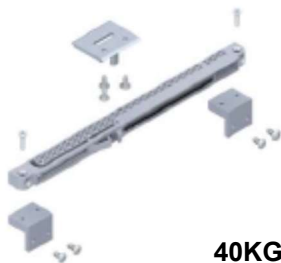

40KG

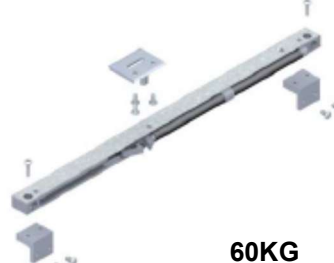

60KG



info@madeter.com
info@racaso.com

maderascasas@maderascasas.com

www.maderascasasteruel.com

Consultar Disponibilidad.

CAJONERAS

Cajoneras postformadas y enlazadas.

Variedad de frentes y posibilidades

The logo for 'Inper' is displayed in a stylized, italicized font. The letters are filled with a gradient of colors, transitioning from blue on the left to yellow and orange on the right.

info@madeter.com
info@racaso.com

maderascasas@maderascasas.com

www.maderascasasteruel.com

I 9. TAPETAS MDF

STOCK

TAPETAS MDF:

PRELACADO
LACADO ALEMÁN
SAPELY / PINO / BARNIZ/S/B
ROBLE/ BARNIZ / S/B
HAYA VAP/ BARNIZ / S/B

MEDIDAS: 70*10
70*12
70*16
90*10
90*12
90*16



TAPETA EXTENSIBLE



TAPETA SIN CLAVOS

TAPETA DM-CHAPA

BATIDEROS MDF:

- EXTENSIBLE O SIN CLAVOS
- SIN GOMA
- CON GOMA (BAJO PEDIDO)



PRELACADO
LACADO ALEMÁN
SAPELY / PINO / BARNIZ/S/B
ROBLE/ BARNIZ / S/B
HAYA VAP/ BARNIZ / S/B

MEDIDAS:

- 60*20
- 70*20
- 80*20
- 90*20
- 100*20
- 110*20
- 120*20
- 130*20
- 140*20
- 150*20

MEDIDAS:

- 60*30
- 70*30
- 90*30
- 80*30
- 100*30
- 110*30
- 120*30
- 130*30
- 140*30
- 150*30



info@madeter.com
info@racaso.com

ias.com

www.maderascasasteruel.com



20. VENTANAS

Consultar Disponibilidad.

Material: La materia utilizada para su fabricación es 100% madera natural (maciza o laminada), renovable, inagotable y su consumo favorece la forestación local y protección del medio ambiente.

La ventana de madera por su naturaleza alveolar proporciona unos niveles importantes de aislamiento térmico, aportando una sensación de bienestar y validez que ningún otro material puede igualar.

Naturaleza y técnica: La fusión de la naturaleza y la técnica hacen que esta ventana adquiera grandes prestaciones, sometiéndola periódicamente a pruebas de laboratorio para asegurar su perfecta estanqueidad y cumplimiento de las normativas.



info@madeter.com
info@racaso.com

maderascasas@maderascasas.com

www.maderascasasteruel.com

VENTANAS DE MADERA



SERIE 69



SERIE 89

VENTANAS MIXTAS



SERIE HERMOD 70



SERIE ASTRO 9 PLUS



SERIE ASTRO 10 PLUS



info@madeter.com
info@racaso.com

maderascasas@maderascasas.com

www.maderascasasteruel.com



STANDARD



BRONZO



INTEGRALE



CLIMA



SCORREVOLI

COMPLANARE



VERBUND



COMFORT



ALZANTI



La madera por sí misma es una materia con baja termoconductividad con lo cual es altamente eficaz contra la formación de condensación de agua, aislamiento térmico y acústico.

Si a esta ventana de madera le ponemos el cristal adecuado podemos alcanzar un coeficiente de transmitancia térmica de $UW=0,8 \text{ W/m}^2\text{K}$. Con lo cual se convierte en cerramiento ideal para la construcción de Passivhaus, obteniendo un bajo consumo de energía, una menor contaminación del medio ambiente y un considerable ahorro económico.

Nome progetto:	isoterme	Temperatura interna:	20.00 °C	Nome progetto:	isoterme	Temperatura interna:	20.00 °C
Visualizzazione:	Report	Temperature esterna:	0.00 °C	Visualizzazione:	Report	Temperature esterna:	0.00 °C
Trasmittanza (U):	0.936 W/m²K	Umidità interna:	40.00 %	Trasmittanza (U):	1.017 W/m²K	Umidità interna:	40.00 %
Conduttanza 2D (Lf2D):	0.393 W/mK			Conduttanza 2D (Lf2D):	0.246 W/mK		
Larghezza telaio (Bf):	132.01 mm			Larghezza telaio (Bf):	110.00 mm		

Calcolo della trasmittanza termica U in conformità con UNI EN ISO 10077-2:2007

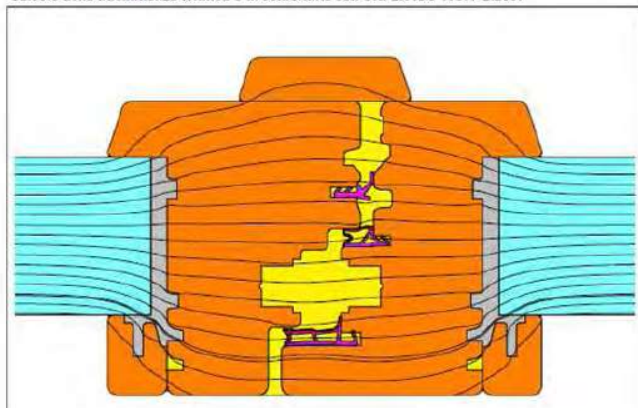

Calcolo della trasmittanza termica U in conformità con UNI EN ISO 10077-2:2007

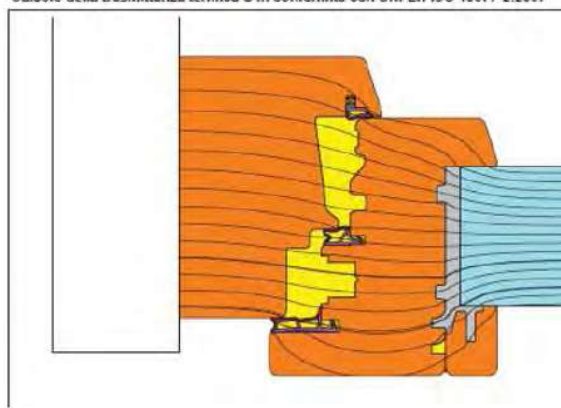

ACRISTALAMIENTO

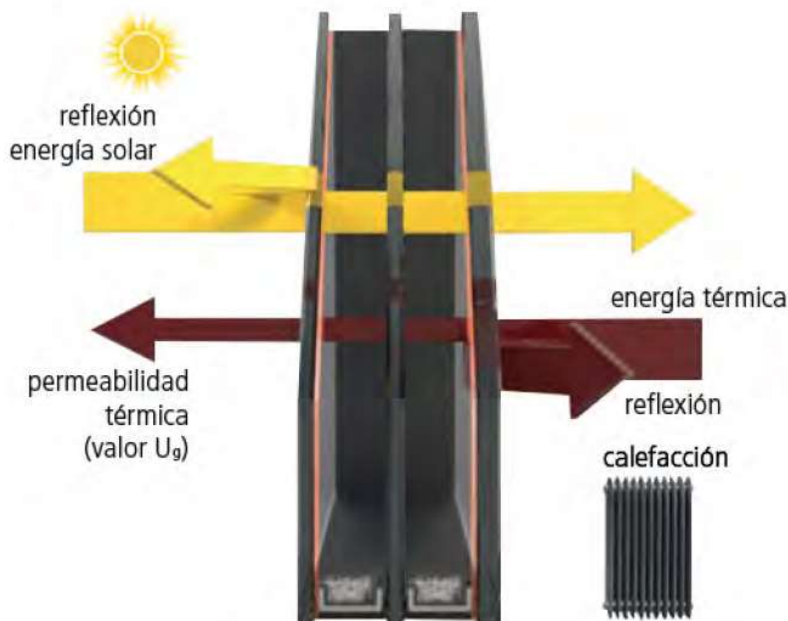

El vidrio es un elemento fundamental en el cerramiento. Su principal propiedad es la transparencia, permitiendo elevados aportes de luz natural sin comprometer sus prestaciones de aislamiento térmico (W/m^2K), acústico (dB) y la seguridad.

La composición del vidrio se realiza en función de las necesidades de cada construcción pudiéndose alcanzar grandes prestaciones térmicas, acústicas y de seguridad



PUERTAS



Las puertas **W-JART** están diseñadas con un perfil similar al de las ventanas que nos asegura una perfecta estanqueidad.

Se fabrica con una sección de 69 mm, apestañada, con doble junta de goma, bisagras regulables y en la parte inferior se puede solucionar con solera plana para salvar barreras arquitectónicas o burlete inferior oculto.

En cuanto a la seguridad, disponen de 5 puntos de cierre perimetrales y cerradura de seguridad en la fabricación estándar, a partir de ahí se puede reforzar la seguridad con blindajes, cerraduras automáticas, escudos anti vandálicos y bombines de alta seguridad.



info@madeter.com
info@racaso.com

maderascasas@maderascasas.com

www.maderascasasteruel.com

VENTANAS PARA TEJADO

Serie 43

Pendientes admisibles de 15° a 85°



PIVOTANTE



BASCULANTE

APERTURA MÁXIMA 45°

Ventana para tejado Roto serie 43, fabricada en madera de pino nórdico de primera calidad, completamente barnizada en todas sus caras. Serie 43 de PVC de color blanco reforzado con perfil metálico, ideal para instalar en cocinas, baños y zonas húmedas. Ambas versiones están recubiertas exteriormente con perfilería de aluminio en color marrón (RAL 8019) sin ningún tornillo exterior en contacto directo con la madera. Posibilidad de combinación con la ventana Serie 43, 73, 84 y ventana vertical.

Serie 73

Pendientes admisibles de 15° a 65°



TOP PIVOTANTE/ PROYECTANTE



BASCULANTE

APERTURA MÁXIMA 38°

Se caracteriza por su apertura TOP-pivotante / proyectante. El eje de rotación, situado en el tercio superior de los laterales de la ventana proporciona la sensación de una apertura proyectante, se aconseja colocarla en medias y bajas alturas ya que ofrece amplia visibilidad exterior. Existen dos versiones:

La serie 73 fabricada de madera, de pino nórdico de primera calidad, completamente barnizada en todas sus caras.

La serie 73-PVC de color blanco reforzado con perfil metálico. Ideal para instalar en cocinas, baños y zonas especialmente húmedas y representa la mejor opción cuando se deba combinar con otro tipo de ventanas de PVC de la vivienda.



info@madeter.com
info@racaso.com

maderascasas@maderascasas.com

www.maderascasasteruel.com

21. COCINAS

Consultar Disponibilidad.

PUERTAS DE COCINA

Syncron[®] by ALNIC
structured panel LINE



Anniversary Oak 02 *



Anniversary Oak 01 *



Anniversary Oak 03 *



Nogal Rosales 02 *



Nogal Rosales 01 *



info@madeter.com
info@racaso.com

maderascasas@maderascasas.com

www.maderascasasteruel.com

118



Como Ash 01 *



Como Ash 02 *



Art Oak 03 *



Nogal Rosales 03 *



Lakeland Oak 01



Lakeland Oak 03



Woodline 03 BA



Picasso 01 AR **NEW**



Picasso 03 AR **NEW**



Vulcano MI **NEW**



Noce 01



Noce 03



Picasso 02 AR **NEW**



Vitamine MI **NEW**





Oxid 03 Brown SS



Oxid 04 Grafitt SS



Factory 01 ORT



Factory 02 ORT



Titan 01 PT



Spatt 01 Blanco VE



Cross Metal Titanio



Cross Metal Copper



Porcelain 01 Gold JA



Porcelain 02 Gold JA



Porcelain 03 Silver JA



Siena ST

NEW



Acabados naturales
Natural finishes
Finitions naturelles



Tratamiento Antibacteria
Antibacterial Treatment
Traitement antibaotérien



Limpieza fácil
Easy cleaning
Nettoyage facile

**DISPONIBILIDAD DE CATALOGO
COMPLETO EN PDF**



info@madeter.com
info@racaso.com

maderascasas@maderascasas.com

www.maderascasasteruel.com
120

PUERTAS DE COCINA



Vitamime DY **NEW**



Blanco Polar DY **NEW**



Blue Fresco DY **NEW**



Blanco JZ



Ice Cream 01 JA



Vulcano DY **NEW**



Raso DY **NEW**



Ice Cream 02 JA

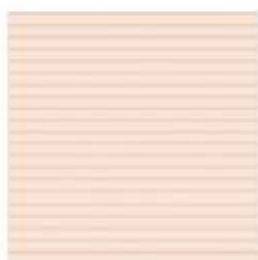

Raso AV **NEW**



Vitamime AV **NEW**



Vulcano AV **NEW**



Roble Muratti 01



Roble Muratti 04

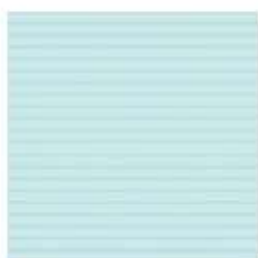

Blue Fresco AV **NEW**



Blanco Polar AV **NEW**



Acabados naturales
Natural finishes
Finitions naturelles



Tratamiento Antibacteria
Antibacterial Treatment
Traitement antibactérien



Limpieza fácil
Easy cleaning
Nettoyage facile



info@madeter.com
info@racaso.com

maderascasas@maderascasas.com

www.maderascasasteruel.com



Blanco SM



Blanco Polar SM



Magnolia SM



Cashmere SM



Basalto SM



Arena SM



Ginger SM

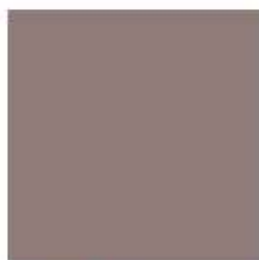

Tortora SM



Camel SM



Almagra SM



Verde Salvia SM



Agua Marina SM



Azul Índigo SM



Azul Marino SM



Cotto SM



Gris Nube SM



Gris Plomo SM



Antracita SM



Negro SM



Burdeos SM



Tacto Seda
Silk Touch
Toucher soie



Larga Durabilidad
Long Durability
Durabilité



Anti-huella
Stain resistance
Résistance aux taches



info@madeter.com
info@racaso.com

maderascasas@maderascasas.com

www.maderascasasteruel.com



Dieffen / Design / Design :
Zénit Almagra SM



ALNIC

Just in Time



Porcelain 01 Gold SM



Porcelain 03 Silver SM



Marmol Venilia SM



Osmia Plata SM



Steelboard Grafita SM

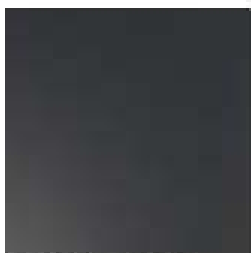

Metal Plus Titanio



Metal Plus Champagne



Metal Plus Light Gold



Metal Plus Copper



Steelboard Copper SM



Cashmere MD



Gris Nube MD



Basalto MD



Antracita MD



Steelboard Aluminio SM



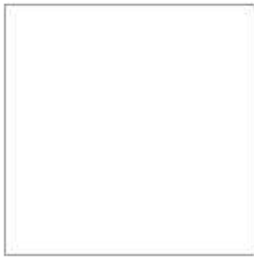

Blanco



Blanco Polar *



Magnolia



Cashmere



Gris-2



Basalto



Gris Nube



Gris Plomo



Antraquita

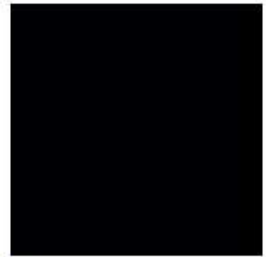

Negro



Verde Salvia



Agua Marina



Azul Índigo **



Azul Marino



Cotto



Rojo



Burdeos



Alto Brillo
High gloss
Haute brillance



Larga Durabilidad
Long Durability
Durabilité



Alta resistencia al rayado
Highly scratch-resistant
Haute résistance aux rayures



info@madeter.com
info@racaso.com

maderascasas@maderascasas.com

www.maderascasasteruel.com



Cromo Blue



Cromo Peach



Nogal Rosales 02 **



Metallo 01 Silver



Metallo 04 Graffiti



Porcelain 01 Gold **



Nogal Rosales 03 **



info@madeter.com
info@racaso.com

maderascasas@maderascasas.com

www.maderascasasteruel.com



Quadro



Pieza 4 Cantos
Piece 4 Edges
Pièce 4 bords



Finger-Pull



Tirador Integrado
Integrated Handle
Poignée intégrée



Diseño / Design / Design :
Synchron Anniversary Oak 02

Synchron



Anniversary
Oak 01



Anniversary
Oak 02



Picasso
01 AR



Picasso
02 AR



Blanco
JZ

s@maderascasas.com

maderascasas.com

Tirador integrado



ZÉNIT Verde Salvia SM

Luxe

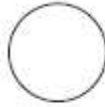

Blanco



Cashmere



Gris Nube



Magnolia



Zénit

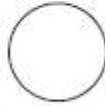

Blanco SM



Basalto SM



Cashmere SM



Gris Nube SM



Magnolia SM



Negro SM



Verde Salvia SM



Sincron



Anniversary Oak 01



Anniversary Oak 02



Art Oak 03



Nogal Rosales 02



Nogal Rosales 03



Nocce 01



Nocce 03



Picasso 02 AR



Roble Muratti 04



Tirador / Handle / Poignée :



Color de la puerta /
Door colour / Couleur de la porte



Aluminio /
Aluminum / Aluminium

Mallorca



Menorca



Tenerife



Lanzarote



STOCK

MODELOS ALTOS, FONDO 33	
MEDIDA	MEDIDA
	60*60 SC
70*30	90*30
70*35	90*35
70*40	90*40
70*45	90*45
70*50	90*50
70*60	90*60
70*70	90*70
70*80	90*80
70*90	90*90
70*100	90*100

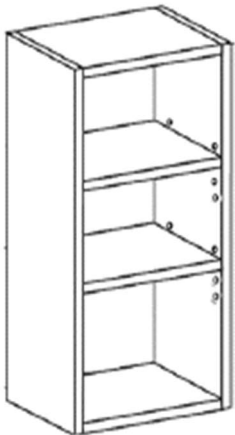
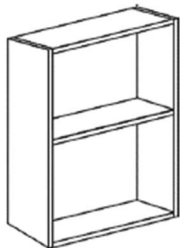

MEDIDA	
35*60	TRANSVERSAL
40*60	TRANSVERSAL
40*80	TRANSVERSAL

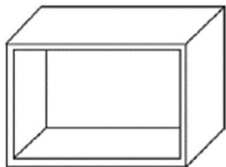

-ESCURREPLATOS	
MEDIDA	MEDIDA
70*50	90*45
70*60	90*50
70*70	90*60
70*80	90*70
70*90	90*80
	90*90

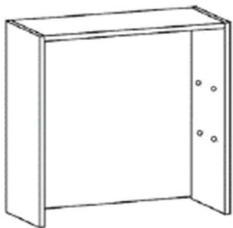

RINCON CHAFLÁN
MEDIDA
ALTO 70*63
ALTO 90*63

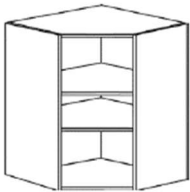

RINCÓN "L"
MEDIDA
ALTO 70*63
ALTO 90*63

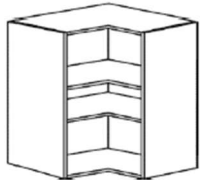

MODELOS BAJOS, FONDO 58

MEDIDA	MEDIDA
70*30	80*30
70*35	80*35
70*40	80*40
70*45	80*45
70*50	80*50
70*60	80*60
70*70	80*70
70*80	80*80
70*90	80*90
70*100	80*100
	80*120

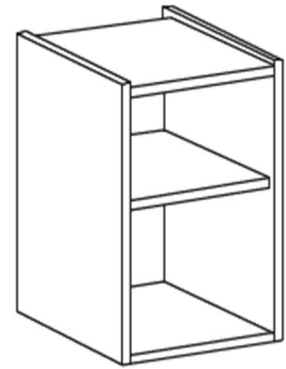

MODULO BAJO FREGADERO

MEDIDA	MEDIDA
70*45	80*45
70*50	80*50
70*60	80*60
70*70	80*70
70*80	80*80
70*90	80*90
70*100	80*100

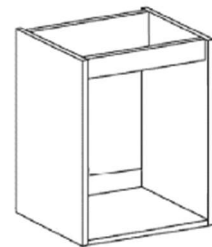

MODULO HORNO

MEDIDA	MEDIDA
70*60	80*60

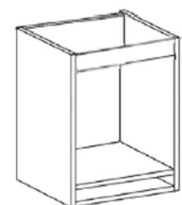

MODULO COLUMNA

MEDIDA
2200*40
2200*60

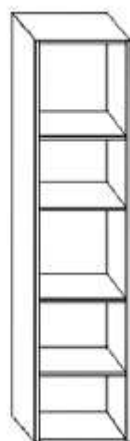

RINCÓN "L"

MEDIDA
BAJO 70*93
BAJO 80*93

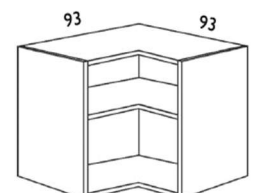

ENCIMERAS Medidas: 3600*620*30mm

STOCK



EP-002-SF / Blanco Soft



● ● EP-031-BR / Granito Clásico



● EP-112-GLS / Snow Terraz Blanco



● ● EP-096-OP
Nogal Parquet



● ● EP-050-MT / Mármol Micado

ENCIMERAS Medidas: 3600*620*38mm



EP-124-OP
Roble Sonoma Nat



● ● EP-091-IS
Cemento Natural



● ● EP-092-IS
Cemento Oscuro



● ● EP-141-NAT
Anniversary 02 Oak



● ● EP-086-IS
Fresko 51301



EP-138-PI
Piedra Tripura



● ● EP-142-SN
Roble Ibérico



● ● EP-151-ST / Mármol Marquina



● ● EP-140-SM
Mármol Versilia



● ● EP-090-PI
Piedra Carbón



info@madeter.com
info@racaso.com

maderascasas@maderascasas.com

www.maderascasasteruel.com

130

encimeras FINTOP LAM

Finsa



SOPORTE Compac Plus EZ 3600x630x13 mm - 29 kg/ud

CANTO FRONTAL Postformado doble: Radio 5 mm

OBSERVACIONES La diversidad de colores y posibilidades permiten que este producto se utilice también para otras aplicaciones como: mesas de trabajo, mobiliario de hostelería, etc.

Disponibilidad de:

- Lámina para canto de cada diseño para remates.
- Perfiles de aluminio para unión en recto y esquina.
- Tablero para panelar 3600x1400x13mm
- Copete/Zócalo en 3600x150x13mm

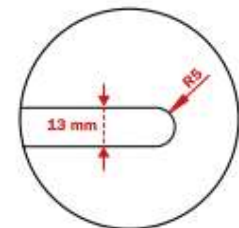

3476- Black Emperor
Velvet (*)



3450- Summer Storm
Velvet (*)



3451- Winter Storm
Velvet (*)



info@madeter.com
info@racaso.com

maderascasas@maderascasas.com

www.maderascasasteruel.com



MOSTRADOR ALVIC 3600*700*38 mm
MOSTRADOR ALVIC 3600*800*38 mm
MOSTRADOR ALVIC 3600*900*38 mm



Consultar Disponibilidad.



info@madeter.com
info@racaso.com

maderascasas@maderascasas.com

www.maderascasasteruel.com

COMPLEMENTOS COCINA

STOCK

Stock Disponible

COPETE CLÁSICO:



COPETE D7:



Aluminio Cepillado



NUEVO Negro Mate



NUEVO Blanco Mate

Blanco Mate



TERMINACION ENCIMERA



T-EMPALME



T- POSTFORMADA

COPETE DECORATIVO

PANEL MURAL ENCIMERA



Tira laminada 3600x1400



Medidas: 3000 x 630 x 9 mm.



info@madeter.com
info@racaso.com

maderascasas@maderascasas.com

www.maderascasasteruel.com

TIRADORES



N°408



N.º 107



TIRAD CAIRO PL VIEJA



PAPUA



DUKE

DISPONIBILIDAD DE CATALOGO
COMPLETO EN PDF



info@madeter.com
info@racaso.com

maderascasas@maderascasas.com

www.maderascasasteruel.com



TIRADOR "U"



TIRADOR DINO



TIRADOR "U"



TIRADOR SENSE NEGRO



TIRADOR SENSE INOX



TIRADOR BUTTON



TIRADOR BUTTON



TIRADOR ESTE



ADVÄNCED H87 ADVÄNCED H167



Embalaje individual



Set Barra Gaveta Alt. Libre Antracita Set Barra Gaveta Alt. Libre Blanco



info@mader.com
info@racaso.com

maderascasas@maderascasas.com

www.maderascasasteruel.com

BISAGRAS MÓDULOS:

Cod. 1247507

Grosor de la puerta de 14 a 23 mm, regulación de la puerta horizontal de 0-5mm y profundidad de 0-4mm. Cierre diferenciado de muelle. Sistema automático de montaje de la bisagra al suplemento.



BISAGRA RECTA CON FRENO + BASE + CUBRECAZOLETA + CUBREBRAZO (DIHERCO)

COMPLEMENTOS MÓDULOS:



COMPLEMENTOS PARA MÓDULOS:

Stock Disponible:



PATAS

- PATAS 13-19 NEGRA
- PATAS9-13 NEGRAS

- ABRAZADERAS
- PARA ZÓCALO PVC DE ALUMINIO
- PARA ZÓCALO DE MADERA
- PARA ZÓCALO DE ALUMINIO



- PROTECTOR PVC ZÓCALO GOMA
- ZÓCALO PVC LAMINADO ALUMINIO CEPILLADO / BLANCO / NEGRO
- ÁNGULO VARIABLE PERNIO ALUMINIO / BLANCO / NEGRO



info@madeter.com
info@racaso.com

maderascasas@maderascasas.com

www.maderascasasteruel.com

137

COMPLEMENTOS COCINA:

STOCK

REJILLA HORNO

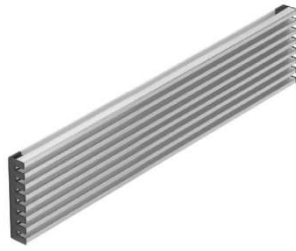

CUBERTERO



MARCO MICROHONDAS



TUBO RECTANGULAR
REF.0601 120*60*1500mm

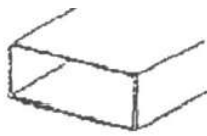

TUBO REDONDO
REF.0605 100*1500mm



EMPALME RECTANGULAR
REF. 0610

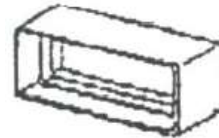

EMPALME REDONDA
REF.0615



EMPALME MIXTO
REF.0620

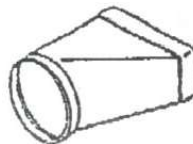

CODO MIXTO
REF.0625



CODO VERTICAL
REF.0630



CODO HORIZONTAL
REF.0635

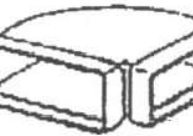

REMATE PARED
REF.0645

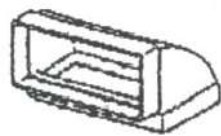
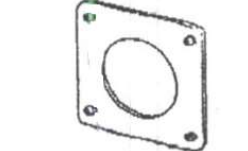

REMATE PARED
REF.0640

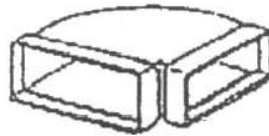

EMPALME REDUCTOR
REF.0660

CODO REDONDO
REF.0670

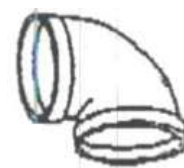

info@madeter.com
info@racaso.com

maderascasas@maderascasas.com

www.maderascasasteruel.com

22. SUELO

STOCK



AC-5
ultra
plus serie

AC-5
ultra
line serie bisel



AGT ULTRA PLUS NATURAL OAK

SUELO LAMINADO AGT ULTRA PLUS AC-5 Y AGT ULTRA LINE AC-5

PAVIMENTO LAMINADO AGT ULTRA PLUS AC-5 Y AGT ULTRA LINE AC-5



Clase 33 |
Classe 33



Garantía doméstica: 30 años |
Garantia doméstica: 30 anos



Fáciles y rápidos de instalar. |
Fáceis e rápidos de instalar.



Resistencia al desgaste: AC5 |
Resistência ao desgaste: AC5



Garantía comercial: 12 años |
Garantia comercial: 12 anos



Higiénicos (evitan alergias y ácaros). |
Higiénicos (evitam alergias e ácaros).



Resistencia al golpeo: IC3 |
Resistência às marcas: IC3



Antiestático |
Antiestático



Aportan decoración. |
Trazem decoração



Hinchazón: < 12 % |
Inchamento: < 12 %



Protección borde contra agua |
Proteção dos bordos contra água



Económicos. |
Económicos.



Fáciles de mantener y limpiar. |
Fáceis de manter e limpar.



AGT ULTRA LINE:
Con Bisel |
Com Bisel.



info@madeter.com
info@racaso.com

maderascasas@maderascasas.com

www.maderascasasteruel.com

AC-5
ultra
plus serie

AC-5
ultra
line serie bisel



TIBET
TIBET C/ BISEL
1200 x 191 x 8 mm



ALTAY
ALTAY C/ BISEL
1200 x 191 x 8 mm

TERMINACIÓN
Textura

TERMINAÇÃO
Texturizado



NATURAL OAK
NATURAL OAK C/ BISEL
1200 x 191 x 8 mm



OLIMPUS
OLIMPUS C/ BISEL
1200 x 191 x 8 mm



NIL
NIL C/ BISEL
1200 x 191 x 8 mm



MERIC
MERIC C/ BISEL
1200 x 191 x 8 mm



TUNA
TUNA C/ BISEL
1200 x 191 x 8 mm



SELGE
SELGE C/ BISEL
1200 x 191 x 8 mm



info@madeter.com
info@racaso.com

maderascasas@maderascasas.com

www.maderascasasteruel.com



AGT PLUS TUNA

SUELO LAMINADO AGT NATURA AC-4 | PAVIMENTO LAMINADO AGT NATURA AC-4:



Clase 32 |
Classe 32



Resistencia al desgaste: AC4 |
Resistência ao desgaste: AC4



Resistencia al golpeo: IC2 |
Resistência às marcas: IC2



Hinchazón: < 16 % |
Inchamento: < 16 %



Fáciles de mantener y limpiar. |
Fáceis de manter e limpar.



Garantía doméstico: 25 años |
Garantia doméstica: 25 anos



Garantía comercial: 10 años |
Garantia comercial: 10 anos



Antiestático |
Antiestático



Proteccion borde contra agua. |
Proteção dos bordos contra água



Fáciles y rápidos de instalar. |
Fáceis e rápidos de instalar.



Higiénicos (evitan alergias y
ácaros). | Higiénicos (evitam
alergias e ácaros).



Aportan decoración. |
Trazem decoração.



Económicos. |
Económicos.



info@mader.com
info@racaso.com

maderascasas@maderascasas.com

www.maderascasasteruel.com



ILGAZ OAK
1200 x 191 x 8 mm



CANYON OAK
1200 x 191 x 8 mm



TREND OAK
1200 x 191 x 8 mm



AP07 - VOLGA
1200 x 191 x 8 mm



AP12 - TALYA
1200 x 191 x 8 mm



AP10 - GALA OAK
1200 x 191 x 8 mm



AP53 - NATURAL OAK



AP54 - OLIMPUS



AP- LUGANO



AP- PORTOFINO



AC-4

effect

Bisel poro sincronizado

EFFECT PREMIUM AC-5
BISEL PORO SINCRONIZADO 12 MM



AGT EFFECT PAMIR

SUELO LAMINADO AGT EFFECT AC-4 Y EFFECT PREMIUM AC-5 | PAVIMENTO LAMINADO AGT EFFECT AC-4 Y EFFECT PREMIUM AC-5:

	Garantía doméstica: 30 años Garantía doméstica: 30 anos		Fáciles de mantener y limpiar. Fáceis de manter e limpar.		Con Bisel Com Bisel.		Aportan decoración. Trazem decoração.
	Garantía comercial: 12 años Garantía comercial: 12 anos		Antiestático Antiestático		Fáciles y rápidos de instalar. Fáceis e rápidos de instalar.		Visual Sincronizado Visual Sincronizado
	Hinchazón: < 12% Inchamento: < 12%		Protección borde contra agua Proteção dos bordos contra água		Higiénicos (evitan alergias y ácaros). Higiénicos (evitam alergias e ácaros).		

SUELO LAMINADO AGT EFFECT AC-4 | PAVIMENTO LAMINADO AGT EFFECT AC-4:

	Clase 32 Classe 32		Resistencia al desgaste: AC4 Resistência ao desgaste: AC4		Resistencia al golpeo: IC2 Resistência às marcas: IC2
--	-------------------------	--	--	--	--

SUELO LAMINADO AGT EFFECT PREMIUM AC-5 | PAVIMENTO LAMINADO AGT EFFECT PREMIUM AC-5:

	Clase 33 Classe 33		Resistencia al desgaste: AC5 Resistência ao desgaste: AC5		Resistencia al golpeo: IC3 Resistência às marcas: IC3
--	-------------------------	--	--	--	--



info@madeter.com
info@racaso.com

maderascasas@maderascasas.com

www.maderascasasteruel.com



EFFECT PREMIUM AC-5
BISEL
PORO SINCRONIZADO
12 MM



ALP
1200 x 191 x 8 mm
1200 x 191 x 12 mm



PAMIR
1200 x 191 x 8 mm
1200 x 191 x 12 mm

TERMINACIÓN
Textura Sincro

TERMINAÇÃO
Texturizado Sincronizado



URAL
1200 x 191 x 8 mm
1200 x 191 x 12 mm



FUJI
1200 x 191 x 8 mm
1200 x 191 x 12 mm



TIBET
1200 x 191 x 8 mm
1200 x 191 x 12 mm



ALTAY
1200 x 191 x 8 mm
1200 x 191 x 12 mm



EVEREST
1200 x 191 x 8 mm
1200 x 191 x 12 mm



TOROS
1200 x 191 x 8 mm
1200 x 191 x 12 mm



info@madeter.com
info@racaso.com

maderascasas@maderascasas.com

www.maderascasasteruel.com

YILDIZ				
Medidas	1805 x 243 x 8 mm	Biselado	m² / Caja	2,193
			m²/palets	131,58
Capa uso		Sistema de Anclaje	N° cajas/palets	

PSTYXLAGPE697	Agva
PSTYXLCPE695	Cide
PSTYXLKPE694	Kerpe
PSTYXLCPE846	Cebeci
PSTYXLAPE696	Amasra

Agva

Cide

Kerpe

Cebeci

Amasra

Finfloor



catálogo



info@madeter.com
info@racaso.com

maderascasas@maderascasas.com

www.maderascasasteruel.com

146

Núcleo



HDF Bajo Hinchamiento (< 8%)



Baja emisión de formaldehído

Durabilidad



Resistencia a la abrasión



Comercial intenso
Doméstico intenso
(EN ISO 13329)



Apto para
baños y cocinas

Garantías



Seguridad



Antiestático
(EN 14041/EN 1815)



Reacción al fuego Bfl-S1
(EN 14041/EN 13501)

Instalación



Instalaciones de 12 x 12 m
144 m² sin perfiles



Sistema Clic
Tecnología protegida
(EP 0 843 763 - US 6 006 486)



Sellado de cantos



sin bisel

Formato de lama

Evolve 1331 x 194 mm



**ROBLE
ARLES OSCURO**
FINFLOOR - EVOLVE





ROBLE ARLES NATURAL

FINFLOOR - EVOLVE



ROBLE WEXFORD TOSTADO

FINFLOOR - EVOLVE



ROBLE KALMAR ESENCIA

FINFLOOR - EVOLVE

Finfloor



info@madeter.com
info@racaso.com

maderascasas@maderascasas.com

www.maderascasasteruel.com

148



ROBLE KALMAR GRIS

FINFLOOR - EVOLVE



ROBLE VIENA DORADO

FINFLOOR - EVOLVE

Finfloor

RACASO
MADERAS



info@madeter.com
info@racaso.com

maderascasas@maderascasas.com

www.maderascasasteruel.com

149



ROBLE FADO BRISA

FINFLOOR - EVOLVE



ROBLE FADO SOTAVENTO

FINFLOOR - EVOLVE

Finfloor



info@madeter.com
info@racaso.com

maderascasas@maderascasas.com

www.maderascasasteruel.com

150

Finfloor

COLECCIÓN **SUPREME** | suelos

dura
ble

Núcleo



HDF Bajo
Hinchamiento
(< 8%)



Baja emisión de
formaldehído

Durabilidad



Resistencia a la
abrasión



Comercial intenso
Doméstico intenso
(EN ISO 13329)



Apto para
baños y cocinas

Garantías



Seguridad



Antiestático
(EN 14041/EN 1815)



Reacción al fuego Bfl-S1
(EN 14041/EN 13501)

Instalación



Instalaciones de 12 x 12 m
144 m² sin perfiles



Sistema Clic
Tecnología protegida
(EP 0 843 763 - US 6 006 486)



Sellado de cantos



Sin bisel

Formato de lama

Supreme 1310 x 240 mm



**ROBLE
GAIA DOLOMITES**
FINFLOOR - SUPREME



info@madeter.com
info@racaso.com

maderascasas@maderascasas.com

www.maderascasasteruel.com

151



ROBLE GAIA DALMATATA

FINFLOOR - SUPREME



ROBLE GAIA LORETO

FINFLOOR - SUPREME



ROBLE GAIA VICTORIA

FINFLOOR - SUPREME

Finfloor



info@madeter.com
info@racaso.com

maderascasas@maderascasas.com

www.maderascasasteruel.com

152



FRESNO TANGO ETNA

FINFLOOR - SUPREME



ROBLE SELENA TOSTADO

FINFLOOR - SUPREME

Finfloor

RACASO
MADERAS



info@madeter.com
info@racaso.com

maderascasas@maderascasas.com

www.maderascasasteruel.com

153

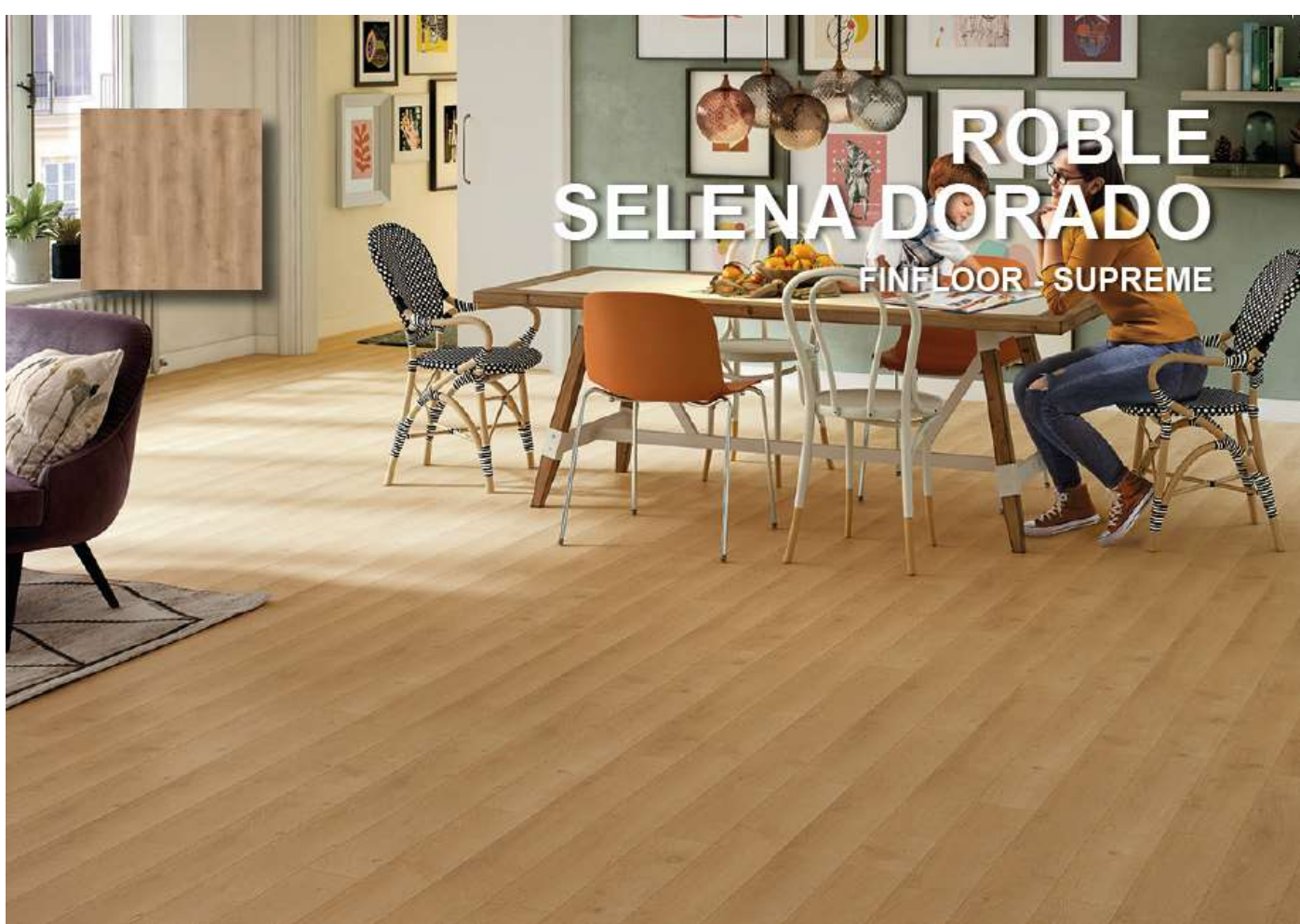

ROBLE SELENA DORADO

FINFLOOR - SUPREME



FRESNO TANGO SANTORINI

FINFLOOR - SUPREME

Finfloor

RACASO
MADERAS



info@madeter.com
info@racaso.com

maderascasas@maderascasas.com

www.maderascasasteruel.com

Finfloor

COLECCIÓN ORIGINAL

suelos

Núcleo



Hydroprotect
HDF alta estabilidad dimensional



Baja emisión de
formaldehído

Durabilidad



Resistencia a la
abrasión



Comercial intenso
Doméstico intenso
(EN ISO 13329)



Apto para baños
y cocinas

Garantías



Seguridad



Antiestático
(EN 14041/EN 1815)



Reacción al fuego Bfl-S1
(EN 14041/EN 13501)

Instalación



Instalaciones de 9 x 9 m
81 m² sin perfiles



Sistema Clic
Tecnología protegida
(EP 0 843 763 - US 6 006 486)



Sellado de cantos



Sin bisel

Formato de lama

Original 1331 x 194 mm



info@madeter.com
info@racaso.com

maderascasas@maderascasas.com

www.maderascasasteruel.com

155

ROBLE CHIC

FINFLOOR - ORIGINAL



ROBLE COLUMBIA

FINFLOOR - ORIGINAL



ROBLE GLAMOUR

FINFLOOR - ORIGINAL



Finfloor



info@madeter.com
info@racaso.com

maderascasas@maderascasas.com

www.maderascasasteruel.com

156



ROBLE RETRO

FINFLOOR - ORIGINAL



ROBLE TAUPE

FINFLOOR - ORIGINAL



ROBLE OBELISQUE

FINFLOOR - ORIGINAL

Finfloor

RACASO
MADERAS



info@madeter.com
info@racaso.com

maderascasas@maderascasas.com

www.maderascasasteruel.com

157



ROBLE CALCIC
FINFLOOR - ORIGINAL



ROBLE PARAMOUNT
FINFLOOR - ORIGINAL



ROBLE VINTAGE
FINFLOOR - ORIGINAL

Finfloor

RACASO
MADERAS



info@madeter.com
info@racaso.com

maderascasas@maderascasas.com

www.maderascasasteruel.com

158



ROBLE TITANIO

FINFLOOR - ORIGINAL



ROBLE SERRADO

FINFLOOR - ORIGINAL



ROBLE OTOÑO

FINFLOOR - ORIGINAL

Finfloor



info@madeter.com
info@racaso.com

maderascasas@maderascasas.com

www.maderascasasteruel.com

159



ROBLE EGEO

FINFLOOR - ORIGINAL



ROBLE BROMO

FINFLOOR - ORIGINAL

Finfloor



info@madeter.com
info@racaso.com

maderascasas@maderascasas.com

www.maderascasasteruel.com
160



ROBLE JASPER

FINFLOOR - ORIGINAL



ROBLE OLIMPO

FINFLOOR - ORIGINAL

Finfloor

RACASO
MADERAS



info@madeter.com
info@racaso.com

maderascasas@maderascasas.com

www.maderascasasteruel.com

Finfloor



PUREFLOOR 7

| suelos



Resistencia a la abrasión
Abrasion-resistant
Resistência à abrasão



Doméstico intensivo
Comercial moderado
High domestic
Moderate commercial
Doméstico intensivo
Comercial moderado
(EN ISO 10874)



Reacción al fuego C_s-s1
Reaction to fire C_s-s1
Reação ao fogo C_s-s1
(EN 14041/EN 13501)



Sellado de cantos
Sealed edges
Selado de cantos



Sin bisel



Garantía
Warranty
Garantia



Fácil instalación
Easy installation
Instalação fácil

Formato · Format · Formato



7 mm
Espesor
Thickness
Espessura

2,582 m²
Caja
Pack
Caixa

x10 uds
Placas
Pack
Peças



info@madeter.com
info@racaso.com

maderascasas@maderascasas.com

www.maderascasasteruel.com

162

ROBLE 3.3

PUREFLOOR



HAYA 3.1

PUREFLOOR



ROBLE SIROCO

PUREFLOOR



Finfloor



info@madeter.com
info@racaso.com

maderascasas@maderascasas.com

www.maderascasasteruel.com

COMPLEMENTOS

FINFLOOR EN BAÑOS Y COCINAS



Silicona de aplicación perimetral



Sellador de juntas

PERFILES DE ALUMINIO

Perfil de expansión

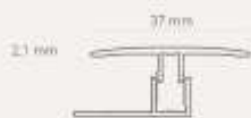

Perfil de transición



Perfil terminal



RODAPIÉS

Rodapiés de color a juego



Clip instalación rodapiés



Junquillo de color a juego



MAMPERLÁN



info@madeter.com
info@racaso.com

maderascas@maderascas.com

www.maderascasasteruel.com

SUELO VINÍLICO

ABSOLUT COMFORT

1810 x 229 x 8 mm

+

**PLUS
COVER**
SOLUTIONS

+

VYCOVER
BY PLUS COVER

Consultar Disponibilidad.



Organza

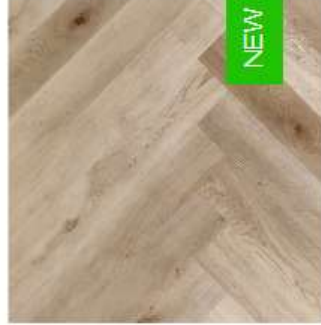

Organza Herringbone



Tahoa



Aspen

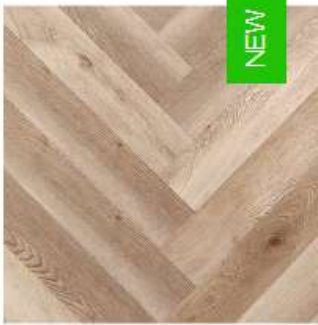

Azure Herringbone



Shale



Azure



Lakehouse OAK



Teal



Dune



Teal Herringbone



info@madeter.com
info@racaso.com

maderascasas@maderascasas.com

www.maderascasasteruel.com

165

Consultar Disponibilidad.

1525 x 310 x 6,5



Alpes



Andes



Terrazo



Travertino



Rocosas

CLIC | Extra Largo



1. Barniz UV
2. Capa de desgaste de 0,70mm
3. Lámina decorativa
4. Núcleo rígido (compuesto de polímero de piedra)
5. Manta acústica de 1,5 mm IXPE



info@madeter.com
info@racaso.com

maderascasas@maderascasas.com

www.maderascasasteruel.com

NEW

+
VYCOVER
BY PLUS COVER

STOCK

ARTECH HD

1520 x 228 x 6 mm



HERMITAGE



TATE



SERRALVES



NATIONAL



PRADO



SOFIA



METROPOLITAN



LOUVRE

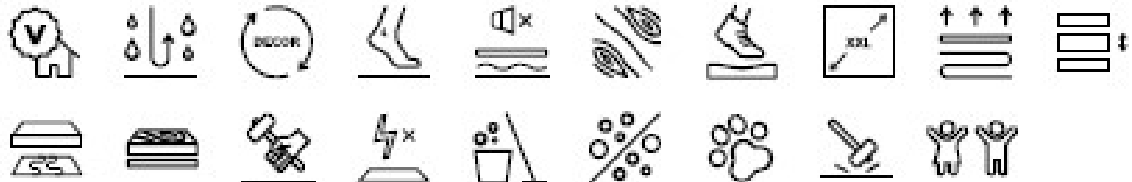

info@madeter.com
info@racaso.com

maderascasas@maderascasas.com

www.maderascasasteruel.com

167

PREMIERCLICK

1220 x 225 x 4,2 mm

STOCK

+

VYCOVER
BY PLUS COVER



Ordesa



Torreón



Picos



Gredos



Mulhacén



Nevosa



Puig



Borosa



Almanzor



Aneto

CLIC

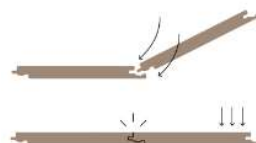

info@madeter.com
info@racaso.com

maderascasas@maderascasas.com

www.maderascasasteruel.com

168

PREMIERCLICK

1220 x 225 x 4,2 mm

+
VYCOVER
BY PLUS COVER



Alcazaba



Moncayo



Peñalara



Maladeta



Veleta

CLIC

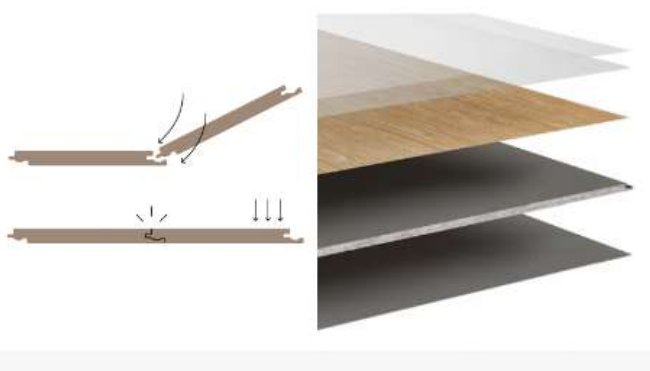

info@madeter.com
info@racaso.com

maderascasas@maderascasas.com

www.maderascasasteruel.com

169

CERAMIC

600 x 300 x 5 mm

STOCK

+

VYCOVER
BY PLUS COVER



Tatun



Cement Black



Cement metal



Cement Grey



Garantía
Residencial - 25 años



A prueba de agua.



Higiénicos
(evitan alergias y ácaros).



Garantía
Comercial - 15 años



Económicos



Fácil de mantener
y limpiar.



Garantía
Residencial - 10 años



Fácil y rápidos
de instalar.



Aportan decoración.



Antiestático.



No desprende olor.



Apto para calefacción
radiante.



info@madeter.com
info@racaso.com

maderascasas@maderascasas.com

www.maderascasasteruel.com

170

Consultar Disponibilidad.

+

DECKCOVER

BY PLUS COVER

TRADICIONAL _



NÍSIROS

2200 x 150 x 25 mm



ETNA

2200 x 150 x 25 mm



SANTORINI

2200 x 150 x 25 mm



VESUBIO

2200 x 150 x 25 mm



Alta resistencia a los agentes atmosféricos y a la radiación UV.



Certificado C3 anti deslizamiento – Apto para edificios públicos, restaurantes, hoteles, terrazas y para piscinas.



Garantía estructural de 25 años para áreas domésticas.
Garantía de desgaste de 15 años para áreas comerciales.



Resistentes al agua

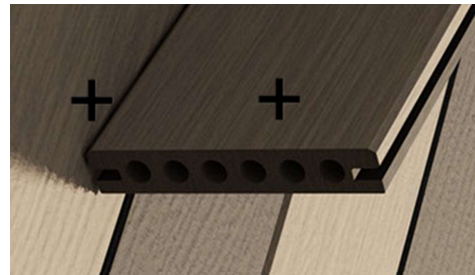
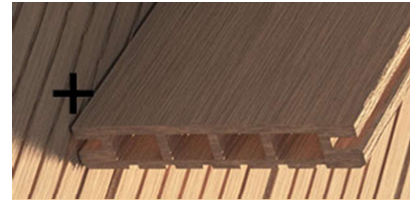

ENCAPSULADO DUO _



DUO SAMBA

2200 x 150 x 23 mm



DUO BORACAY

2200 x 150 x 23 mm



DUO KUTA

2200 x 150 x 23 mm



DUO SAMUI

2200 x 150 x 23 mm



info@madeter.com
info@racaso.com

maderascasas@maderascasas.com

www.maderascasasteruel.com

171

OUTDOOR _

+ **BAMCOVER**
BY PLUS COVER

Gama: Bamcover outdoor

[Consultar Disponibilidad.](#)

Tipo de suelo: Tarima de Bambú

Visual: Bambú

Acabado: ACEITE

Dimensiones: 1860 x 140 x 20 mm
1850 x 139 x 18 mm

Aplicación: GRAPA/RASTREL



KRABI

1860 x 140 x 20 mm



PHUKET

1860 x 140 x 20 mm



Garantía Residencial - 25 años



Comodidad para caminar



A prueba de agua.



Garantía Comercial - 15 años



Materia prima renovable



Materia prima natural



Ecológico.



Certificados C3 antideslizante - Apto para edificios públicos, restaurantes, hoteles, terrazas y para piscinas.



Aportan decoración.



PHUKET



KRABI

Alta estabilidad
Mucho más estable que la mayor parte de maderas tropicales - con las cabezas de lama machihembradas para una fácil instalación (imposible con otras maderas).



info@madeter.com
info@racaso.com

maderascasas@maderascasas.com

www.maderascasasteruel.com

Gama: Bamcover indoor

Tipo de suelo: Tarima de Bambú

Visual: Bambú

Acabado: Barniz satinado ecológico

Dimensiones: 960 x 96 x 15 mm



SHANGAI

930 x 96 x 15 mm



T&G

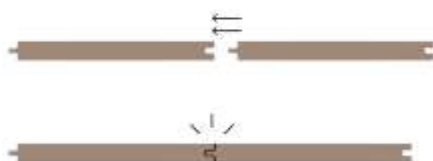

1. Barniz Ecológico UV acrílico
2. Pieza maciza de bambú compuesta de tiras de bambú pegadas verticalmente



info@madeter.com
info@racaso.com

maderascasas@maderascasas.com

www.maderascasasteruel.com



GUILIN

1850 x 142 x 14/4 mm



HARBIN

1850 x 142 x 14/4 mm

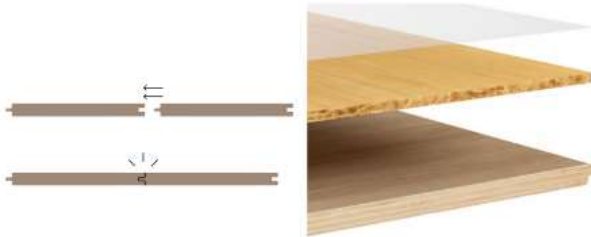

1. Barniz Ecológico UV acrílico Mate
2. Pieza maciza de bambú compuesta de fibras encoladas y prensadas a alta resistencia y temperatura
3. Contrachapado fenólico de alta densidad con gran estabilidad

Gama: Bamcover indoor

Tipo de suelo: Tarima de Bambú

Visual: Bambú

Acabado: Barniz mate ecológico

Dimensiones: 1850 x 142 x 14/4 mm

Aplicación: Flotante T&G



SANYA

920 x 130 x 10/2,5 mm



XIAN

920 x 130 x 10/2,5 mm

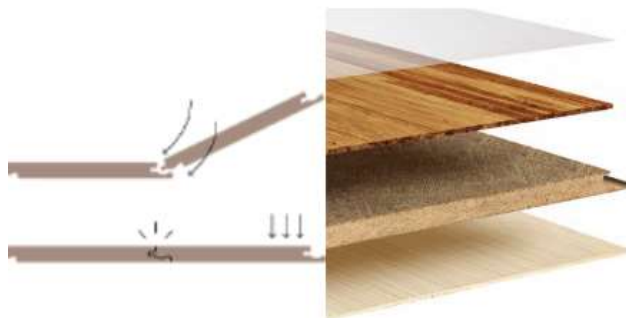

1. Barniz Ecológico UV acrílico Mate
2. Pieza maciza de bambú compuesta de fibras encoladas y prensadas a alta resistencia y temperatura
3. Fibra de alta densidad
4. Madera de Álamo

Gama: Bamcover indoor

Tipo de suelo: Tarima de Bambú

Visual: Bambú

Acabado: Barniz mate ecológico

Dimensiones: 915 x 130 x 10/2,5 mm

Aplicación: Flotante CLIC



OAK Gran Natura

+
**PLUS
COVER**
SOLUTIONS

+
WOODCOVER
BY PLUS COVER



Quebec



Texas



Laval



Toronto



Vancouver



Montreal

El suelo sin terminar -
crudo, requiere sellar con
aceite o barniz para suelos
de madera
Roble europeo con nudos
característicos de esta
madera natural



Garantía
Residencial - 25 años



Higiénicos
(evitan alergias y ácaros).



Producto natural.



Tabla extra larga y extra
ancha.



Fácil de mantener
y limpiar.



1. Barniz UV acrílico o
crudo
2. Capa noble de roble
seleccionado
3. Contrachapado fenólico
de alta densidad con
dureza y estabilidad



info@madeter.com
info@racaso.com

maderascasas@maderascasas.com

www.maderascasasteruel.com



Bilbo



Bruselas



Sevilla



Donosti



Zaragoza



Gasteiz



Toledo



info@madeter.com
info@racaso.com

Cordoba

maderascasas@maderascasas.com

Versage Herringbone

www.maderascasasteruel.com



Crudo



Gyor



Debrecen

OAK Natura - PREMIUM

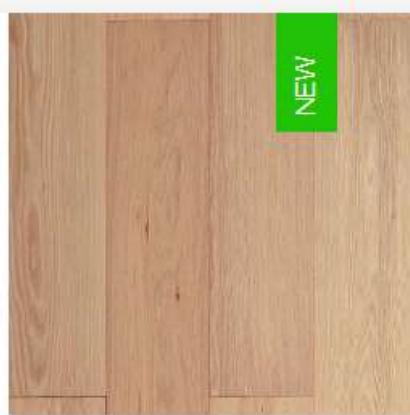

Paris



Singapur

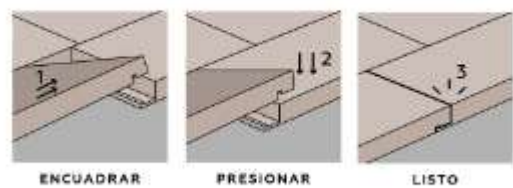
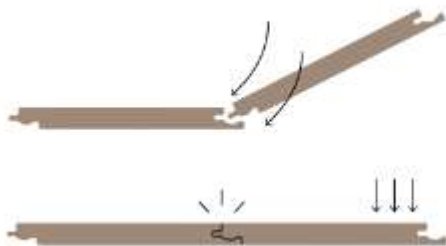

info@madeter.com
info@racaso.com

maderascasas@maderascasas.com

www.maderascasasteruel.com

STOCK



BERGE

PARQUET ROBLE RÚSTICO BERGE 3
LAMAS CLIC 2200*207*14/3,2 (3,18 m²).m²



BALCEI

PARQUET ROBLE RÚSTICO BALCEI 3
LAMAS CLIC 2200*207*14/3,2 (3,18 m²).m²



info@madeter.com
info@racaso.com

maderascasas@maderascasas.com

www.maderascasasteruel.com

IPE

STOCK

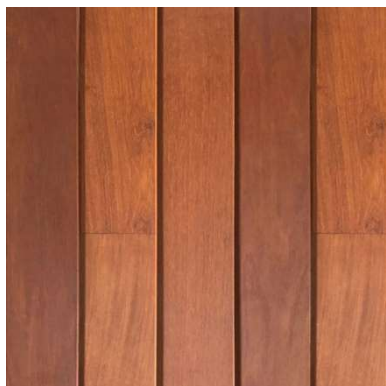

DECK IPE GRAPA OCULTA

- 95*2mm

DECKING IPE BRASIL GRPA OCULTA

- 140*21mm
- 90*21mm

FINGER MULTIJOIN DE LAPACHO GRAPA OCULTA

- 130*21mm
- 140*21mm
- 145*21mm
- 80*15mm
- 95*15mm

DECK SUCUPIRA GRAPA OCULTA

- 120*20mm
-

DECK IPE GRAPA VISTA

- 100*20mm
- 95*20mm
- 95*21mm

FINGER MULTIJOIN IPE GRAPA VISTA

- 11.5*21mm
 - 90*21mm
 - 100*21mm
 - 120*21mm
-



MOD. 156



MOD. 120



info@madeter.com
info@racaso.com

maderascasas@maderascasas.com

www.maderascasasteruel.com

23. MOPA Y RODAPIÉ

STOCK

+ UNDERCOVER
BY PLUS COVER



EPE FOAM 2 MM CON
PELICULA DE PASTICO



EPE FOAM 3 MM CON
PELICULA DE ALUMINIO



EVA 2 MM CON PELICULA DE
PASTICO



EVA 1.5 MM CON FILM DE
ALUMINIO



IXPE 2 MM ACUSTICO
ALUMINIO



LVT 1.2 MM



CORCHO ACUSTICO 2MM



MULTICORK 10 MM



info@mader.com
info@racaso.com

maderascasas@maderascasas.com

www.maderascasasteruel.com

180



**MOPA BLANCA FOAM-
POLIESTILENO EXPANDIDO 3mm
con film**

**MOPA SOUND PLUS 2mm CON
BARRERA DE VAPOR**

**MOPA 2mm LAMINADO CON
SOLAPA AZUL DENSIDAD
MEDIA**



MOPA SILENT ELITE FINSA

**MOPA LATEX d BCOVER HP 2.0
ANTIESTATICA HD 2mm**



**MOPA LATEX d BCOVER ALUMINIO
RADIANTE 1008**

**MOPA LATEX d BCOVER HD 1.5 mm
LVT VINILICO**



info@madeter.com
info@racaso.com

maderascasas@maderascasas.com

www.maderascasasteruel.com

RODAPIÉ MDF SINTETICO MOD R-2:

Stock Disponible:



MEDIDA

- 70*12
- 90*12
- 70*16
- 90*16
- 100*16
- 120*16

RODAPIÉ MDF BLANCO MOD R-2:



MEDIDA

- 70*12
- 90*12
- 70*16
- 90*16
- 100*16
- 120*16



info@madeter.com
info@racaso.com

maderascasas@maderascasas.com

www.maderascasasteruel.com

STOCK

RODAPIE PVC:



MEDIDA

- 70*12
- 90*12
- 100*12

RODAPIE CHAPA MDF MOD R-2:



MEDIDA

- 70*12
- 70*16
- 90*12
- 90*16



info@madeter.com
info@racaso.com

maderascasas@maderascasas.com

www.maderascasasteruel.com

RODAPIE PVC BLANCO:

ANTIHUMEDAD 100%



RODAPIE PVC

- 70*12
- 80*12
- 90*12
- 100*12
- 120*12

PERFIL "L"

- 100*22

MEDIA LUNA

- 15*15

RINCONERA

- 15*15

RODAPIE PVC



RODAPIE PVC PERFIL "L"



MEDIA LUNA



24. FRISOS SINTÉTICOS

MUNDECOR:

STOCK

MEDIDA LAMA 2700*200*10mm (6 TIRAS POR CAJA)



Stock Disponible:

MUNDECOR: BLANCO
MUNDECOR: PINO BLANCO, HAYA, ROBLE, MAPLE, RÚSTICO

CANTONERA 2700*30*10mm
RINCONERA 2700*30*10mm



info@madeter.com
info@racaso.com

maderascasas@maderascasas.com

www.maderascasasteruel.com

185

Bariwall es un revestimiento de paredes y techos en base a PVC. Es un producto de gran calidad decorativa y apto para ambientes húmedos. Se puede instalar rastrelado a la pared o directamente pegado. Es ideal para reformas de baños, cocinas, garajes, pasillos, etc... Se puede instalar a panel completo o a media altura.

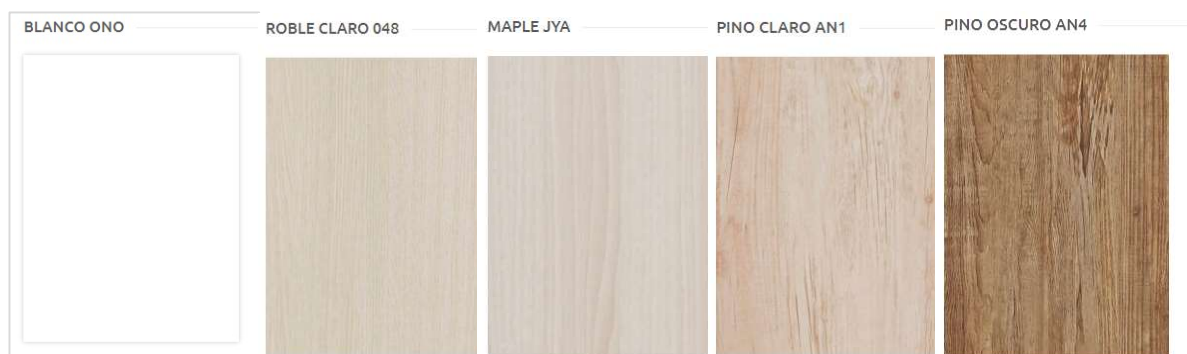

CARACTERÍSTICAS



RESISTENTE A LA LUZ



RECICLABLE



100% RESISTENTE AL AGUA

ÁNGULO VARIABLE



CORNISA

•
•



- Medidas: 2600 X 40 X 7 mm
- Base PVC Espumado

REMATE



RODAPIÉ

•
•



- Medidas: 2200 X 60 X 16 mm
- Base PVC Rígido



MATERIAL DISPONIBLE:

Celosías Sobrepuestas

MEDIDAS: 218 x 85 cm

MADERA DE PINO Y DE ROBLE

MADERA DE PINO



MADERA DE PINO

MADERA DE PINO



Celosías Enrasadas

MEDIDAS: 218 x 85 cm

MADERA DE PINO

MADERA DE PINO Y DE HAYA



MADERA DE PINO

MADERA DE PINO



DISPONIBILIDAD DE OTROS PRODUCTOS BAJO PEDIDO.

<http://www.fama.nu/>



info@madeter.com
info@racaso.com

maderascasas@maderascasas.com

www.maderascasasteruel.com

25. ESCALERAS/FERRETERIA

ESCALERAS ESCAMOTEABLES DE TRAMOS:

Consultar Disponibilidad.

tres tramos / cuatro tramos

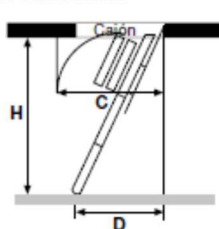

dos tramos

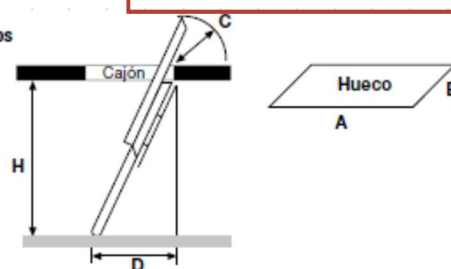

CADET 3 ISO

Madera 3 Tramos
Tramos



CADET 2 ISO

Madera 2 Tramos



EM-3 ISO

Metálica lacada 3 Tramos



PK-4

Metálica galvanizada 4



ESCALERAS ESCAMOTEABLES DE TIJERAS ZX:

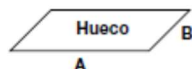
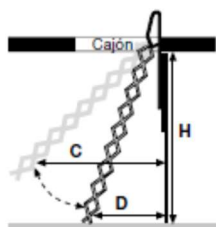

ZX TECHO- Metálica Galvanizada
Metálica Galvanizada



ZX TERRAZA- Metálica Galvanizada ZX

PARED-



info@madeter.com
info@racaso.com

maderascasas@maderascasas.com

www.maderascasasteruel.com

ESCALERAS ESCAMOTEABLES DE TIJERAS MX/LX:

MX-LACADA ISO- MX-ELÉCTRICA ISO

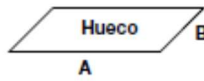
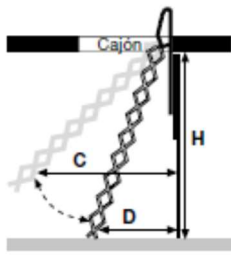

ESCALERAS DE CARACOL:

ESCALERA STAR METÁLICA PINTADA AL HORNO

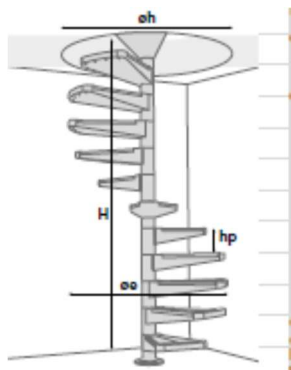

www.maydisa.com/

ESCALERAS RECTAS:

Modelo LISBON

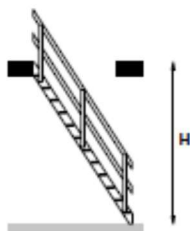

Modelo MADRID

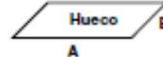
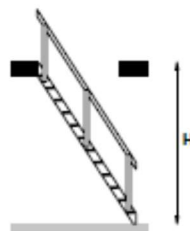

Modelo NORMANDIA

Versión recta

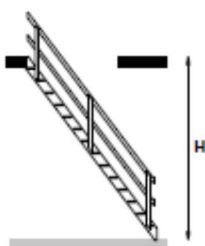

Versión con cuarto de giro

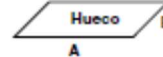
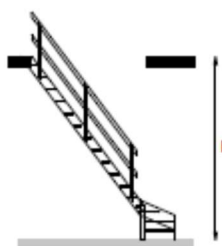

info@madeter.com
info@racaso.com

maderascasas@maderascasas.com

www.maderascasasteruel.com

PASAMANOS

Consultar Disponibilidad.



COMPLEMENTOS

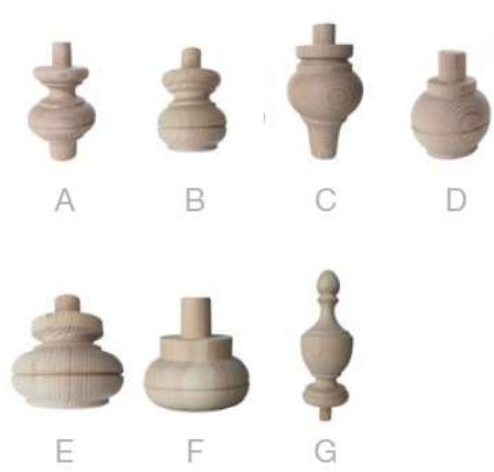

ACCESORIOS

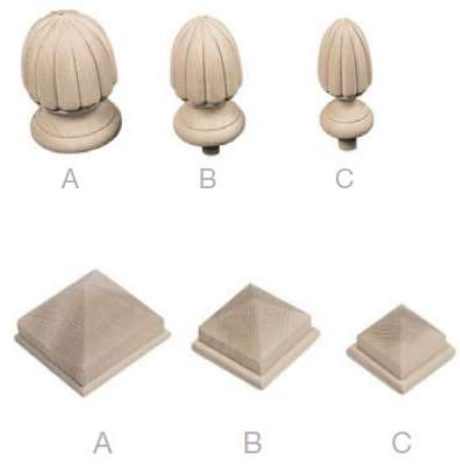

info@madeter.com
info@racaso.com

maderascasas@maderascasas.com

TORNILLOS:

ANCLAJE ANILLA SN CINCADO/ BC

CÓDIGO	MEDIDA mm	BROCA mm	UD/CAJA
*SNZ06045	6x45	6	100
*SNZ06060	6x60	6	100
*SNZ06100	6x100	6	100
*SNZ06120	6x120	6	100
*SNZ06140	6x140	6	100
*SNZ08050	8x50	8	100
*SNZ08075	8x75	8	100
*SNZ08090	8x90	8	100
*SNZ08115	8x115	8	100
SNZ10075	10x75	10	50
SNZ10090	10x90	10	50
SNZ10120	10x120	10	50
SNZ12075	12x75	12	50
SNZ12090	12x90	12	50
SNZ12110	12x110	12	25
SNZ12140	12x140	12	25
*SNZ12180	12x180	12	25
*SNZ16090	16x90	16	25
*SNZ16125	16x125	16	25
*SNZ16145	16x145	16	25
*SNZ16180	16x180	16	10
*SNZ16220	16x220	16	10
*SNZ20160	20x160	20	10
*SNZ20220	20x220	20	10
*SNZ20270	20x270	20	10
*SNZ24200	24x200	24	10
Fixbolt	8*60	10	100
Fixbolt	8*80	10	100
Fixbolt	10*70	12	50
Fixbolt	10*100	12	50



*Material disponible bajo pedido.



info@madeter.com
info@racaso.com

maderascasas@maderascasas.com

www.maderascasasteruel.com

TORNILLOS:

STOCK

TORNILLO HECO SCHRAUBEN

MATERIAL	UD/CAJA
TORNILLO 3,5*25 H.F.P. de TRASERA	1000
TORNILLO 3,5*16 HSI SPEED-plus	1000
TORNILLO 3,5*20 HSI SPEED-Plus	1000
TORNILLO 3,5*25 HSI SPEED-Plus	1000
TORNILLO 3,5*30 HSI SPEED-Plus	1000
TORNILLO 3,5*45 HSI SPEED-Plus	500
TORNILLO 3,5*50 HSI SPEED-Plus	500
TORNILLO 4*50 HSI SPEED-Plus	200
TORNILLO 5*70 POWER CUT C/P T.25 Zinc	200
TORNILLO 6*80 POWER CUT C/P T.30 Zinc	200
TORNILLO 6*100 POWER CUT C/P T.30 Zinc	100
TORNILLO 6*120 POWER CUT C/P T.30 Zinc	100
TORNILLO 6*200 POWER CUT C/P T.30 Zinc	100
TORNILLO 8*300 POWER CUT C/P T.40 Zinc	50
TORNILLO 8*400 POWER CUT C/P T.40 Zinc	50



info@madeter.com
info@racaso.com

maderascasas@maderascasas.com

www.maderascasasteruel.com

SOPORTES Y ANCLAJES:

STOCK



FE500025



FE500050/ FE500060



FE500130



FE500090

FE500445



FE000001



ESTRIBOS



FE500134



KNK361

MATERIAL

FE500025	SOPORTE ANCLAJE PILAR CERRADO 91*91*150
FE500050	SOPORTE ANCLAJE PILAR GRANDE 101*101
FE500060	SOPORTE ANCLAJE PILAR GRANDE 141*141
FE500130	SOPORTE ANCLAJE PILAR DOBLE 161*...
FE500090	SOPORTE ANCLAJE PILAR 201*200
FE500445	SOPORTE ANCLAJE PILAR DE ALTURA REGULABLE BASE 160*160
FE000001	SOPORTE ANCLAJE PILAR REDONDO DIÁMETRO 98
01BA1100	ESTRIBO 100*150
ESTRIBO0168	ESTRIBO 160*80
01BA1120	ESTRIBO 120*175
FE500134	SOPORTE ANCLAJE REGULABLE 130*130
KNK361	UNIÓN SIMPLE 80*40

CABALLETES

STOCK

Material

CABALLETES PINO 80*80



info@madeter.com
info@racaso.com

maderascasas@maderascasas.com

www.maderascasasteruel.com

26. CONSTRUCCIÓN

CONTRACHAPADO FENÓLICO

ENCOFRAR CON FILM:

MATERIAL

- 2500*1250*18
 - 2500*1250*21
 - 2500*1250*24
-

TABLERO DE ENCOFRAR TRICAPA:



MATERIAL

- 2000*500*27mm
-

PINO TABLA GALLEGA



MATERIAL

TABLA GALLEGA 20 mm.m3

TABLA GALLEGA Ancho fijo 25 mm.m3

TABLA GALLEGA Ancho corrido 25 mm.m3

ABETO ASERRADO:



MATERIAL

ABETO 47*150mm

ABETO 50*200mm



info@madeter.com
info@racaso.com

maderascasas@maderascasas.com

www.maderascasasteruel.com

LANA DE ROCA:

ALPHAROCK - E- 225

Panel semi-rígido de lana de roca no revestido.

- APLICACIONES

Aislamiento térmico y acústico de cerramientos verticales, cerramientos horizontales sobre falso techo, en cubiertas inclinadas por el interior, fachadas ventiladas y bajo forjados en contacto por el exterior o espacios no habitables.

MATERIAL DENSIDAD NOMINAL 70KG/M3

- 1350*600*40mm
- 1350*600*60mm



AISLANTES

IMPERMEABILIZACIÓN DE TEJADOS:

Onduline[®]
BAJO TEJA 

LA SOLUCIÓN DEFINITIVA CONTRA GOTERAS Y HUMEDADES

Las placas asfálticas impermeables Onduline Bajo Teja DRS forman una **solución definitiva contra las goteras** dotando al tejado de una protección muy resistente y duradera que protege a la vivienda por muchos años aunque se muevan o desplacen las tejas.



info@madeter.com
info@racaso.com

maderascasas@maderascasas.com

www.maderascasasteruel.com

195

27. JARDINERÍA



Césped Generalife

Gama: Cespcover

Tipo de suelo: Moqueta de césped sintético

Visual: Césped

Dimensiones: 2 x 10 x 35mm / 2 x 25 x 35mm



Césped Generalife

Gama: Cespcover

Tipo de suelo: Moqueta de césped sintético

Visual: Césped

Dimensiones: 2 x 10 x 42mm / 2 x 25 x 42mm



Césped Generalife

Gama: Cespcover

Tipo de suelo: Moqueta de césped sintético

Visual: Césped

Dimensiones: 2 x 10 x 22mm / 2 x 25 x 22mm /



info@madeter.com
info@racaso.com

maderascasas@maderascasas.com

www.maderascasasteruel.com





Sigue nuestras Redes Sociales

Maderas Casas Alcorisa

MaderasCasasAlcorisa 
@maderas_casas_alcorisa 

Maderas Casas Teruel

maderasteruel22 
@maderas_teruel 

Maderas Racaso

MaderasRacaso 
@maderas_racaso 



info@madeter.com
info@racaso.com

maderascasas@maderascasas.com

www.maderascasasteruel.com